

**APPENDIX 1**  
**VERSION B - FORM OF CONNECTION AGREEMENT**  
**FOR GENERATOR CUSTOMERS**

**TABLE OF CONTENTS**

PART ONE: GENERAL

1. DEFINITIONS
2. INTERPRETATION
3. INCORPORATION OF TRANSMISSION SYSTEM CODE
4. SCHEDULES
  - 4.1. Incorporation of Schedules
  - 4.2. Schedules
  - 4.3. Additional Schedules
5. NOTICE
  - 5.1. Method of Giving Notice and Effective Date
  - 5.2. Address for Notice
  - 5.3. Exception
6. ASSIGNMENT
7. FURTHER ASSURANCES
8. WAIVER
9. AMENDMENTS
10. SUCCESSORS AND ASSIGNS
11. ENTIRE AGREEMENT
12. GOVERNING LAW
13. COUNTERPARTS

PART TWO: REPRESENTATIONS AND WARRANTIES

14. REPRESENTATIONS AND WARRANTIES
  - 14.1. Customer's Representations and Warranties
  - 14.2. Transmitter's Representations and Warranties

PART THREE: LIABILITY AND FORCE MAJEURE

15. LIABILITY
16. FORCE MAJEURE
  - 16.1. No Liability Where Force Majeure Event Occurs
  - 16.2. Obligations Where Force Majeure Event Occurs

## PART FOUR: DISPUTE RESOLUTION

- 17. DISPUTE RESOLUTION
  - 17.1. Exclusivity
  - 17.2. Duty to Negotiate
  - 17.3. Submission of Unresolved Disputes to Arbitration
  - 17.4. Selection of Arbitrator(s)
  - 17.5. Arbitration Procedure

## PART FIVE: TERM, TERMINATION AND EVENTS OF DEFAULT

- 18. TERM AND TERMINATION
  - 18.1. Coming into Force
  - 18.2. Termination Without Cause by Customer
  - 18.3. Termination for Cause by Either Party
  - 18.4. Provisions Relating to Termination Generally
  - 18.5. Rights and Remedies Not Exclusive
  - 18.6. Survival
- 19. EVENTS OF DEFAULT AND TERMINATION FOR CAUSE
  - 19.1. Occurrence of an Event of Default
  - 19.2. Curing Events of Default
  - 19.3. Right to Terminate and Disconnect
  - 19.4. Lender's Right of Substitution

## PART SIX: DISCONNECTION AND RECONNECTION

- 20. DISCONNECTION
  - 20.1. Voluntary Permanent Disconnection by Customer
  - 20.2. Voluntary Temporary Disconnection by Customer and Reconnection
  - 20.3. Disconnection by Transmitter
  - 20.4. Reconnection after Disconnection by Transmitter
  - 20.5. Provisions Applicable to Disconnection Generally

## PART SEVEN: EXCHANGE AND CONFIDENTIALITY OF INFORMATION

- 21. EXCHANGE AND CONFIDENTIALITY OF INFORMATION

## PART EIGHT: TRANSMISSION SERVICE AND OTHER CHARGES

- 22. TRANSMISSION SERVICE AND TRANSMISSION SERVICE CHARGES
- 23. OTHER CHARGES AND PAYMENTS

## PART NINE: TECHNICAL AND OPERATING REQUIREMENTS

- 24. FACILITY STANDARDS

- 25. ADDITIONAL TECHNICAL REQUIREMENTS
- 26. OPERATIONAL STANDARDS AND REPORTING
- 27. OPERATIONS AND MAINTENANCE
  - 27.1. Work on Site of Other Party
  - 27.2. General
  - 27.3. Controlling Authorities
  - 27.4. Communication Between the Parties
  - 27.5. Switching
  - 27.6. Isolation of Facilities at Customer's Request
  - 27.7. Isolation of Facilities at Transmitter's Request
  - 27.8. Alternative Method of Isolation
  - 27.9. Forced Outages
  - 27.10. Planned Work
  - 27.11. Shutdown of Customer's Facilities
  - 27.12. Emergency Operations
  - 27.13. Access to and Security of Facilities
- 28. INSPECTION, TESTING, MONITORING AND NEW, MODIFIED OR REPLACEMENT CUSTOMER FACILITIES
  - 28.1. General Requirements
  - 28.2. New, Modified or Replacement Customer Facilities

PART TEN: SCHEDULE J

29. COMPLIANCE WITH SCHEDULE J

- SCHEDULE A: SINGLE LINE DIAGRAM, DESCRIPTION OF THE CUSTOMER'S CONNECTION POINT(S) AND DETAILS OF SPECIFIC OPERATIONS
- SCHEDULE B: TRANSMISSION SERVICES AND ASSOCIATED CHARGES
- SCHEDULE C: CURE PERIODS FOR DEFAULTS
- SCHEDULE D: FAULT LEVELS AND MODIFICATIONS REQUIRING APPROVAL BY THE TRANSMITTER
- SCHEDULE E: GENERAL TECHNICAL REQUIREMENTS
- SCHEDULE F: ADDITIONAL TECHNICAL REQUIREMENTS
- SCHEDULE G: PROTECTION SYSTEM REQUIREMENTS
- SCHEDULE H: FACILITIES DEEMED COMPLIANT AND OBLIGATION TO COMPLY
- SCHEDULE I: EXCHANGE OF INFORMATION
- SCHEDULE J: CONTACTS FOR PURPOSES OF NOTICE
- SCHEDULE K: SPECIAL PROVISIONS

**APPENDIX 1**  
**VERSION B - FORM OF CONNECTION AGREEMENT**  
**FOR GENERATOR CUSTOMERS**

This Connection Agreement is made this \_\_\_\_ day of \_\_\_\_\_, \_\_\_\_\_,

**BETWEEN**

\_\_\_\_\_, a *[insert form of business organization]* duly *[incorporated/formed/registered]* under the laws of *[insert jurisdiction]* (the “Transmitter”)

**AND**

\_\_\_\_\_, a *[insert form of business organization]* duly *[incorporated/formed/registered]* under the laws of *[insert jurisdiction]* (the “Customer”)

(each a “Party” and collectively the “Parties”)

**RECITALS**

WHEREAS the Customer has connected or wishes to connect its facilities to the Transmitter’s transmission system.

AND WHEREAS the Transmitter has connected or has agreed to connect the Customer’s facilities to its transmission system.

AND WHEREAS in accordance with its licence and the Market Rules the Transmitter has agreed to offer, and the Customer has agreed to accept, transmission service in relation to the Customer’s facilities.

**NOW THEREFORE** in consideration of the foregoing, and of the mutual covenants, agreements, terms and conditions herein contained, the Parties, intending to be legally bound, hereby agree as follows:

## **PART ONE**

### **GENERAL**

#### **1. DEFINITIONS**

- 1.1 In this Agreement, unless the context otherwise requires:
- 1.1.1 “Agreement” means this connection agreement and all of the Schedules;
- 1.1.2. “Code” means the Transmission System Code issued by the Board and in effect at the relevant time;
- 1.1.3. “Confidential Information” in respect of a Party means (a) information disclosed by that Party to the other Party under this Agreement that is in its nature confidential, proprietary or commercially sensitive and (b) information derived from the information referred to in (a), but excludes information described in section 21.1;
- 1.1.4. “Controlling Authority” in respect of a Party means the person appointed by that Party as responsible for performing, directing or authorizing changes in the condition or physical position of electrical apparatus or devices;
- 1.1.5. “Cure Period” means the period of time given to a Defaulting Party for the purposes of remedying an Event of Default, determined in accordance with section 19.2.1;
- 1.1.6. “Default Notice” has the meaning given to it in section 19.1.1;
- 1.1.7. “Defaulting Party” means a Party in relation to whom an Event of Default has occurred or is occurring;
- 1.1.8. “End of Cure Period Notice” has the meaning given to it in section 19.2.3;
- 1.1.9. “Event of Default” means a Financial Default or a Non-financial Default;
- 1.1.10. “Export Transmission Service” has the meaning given to it in the Transmitter’s Rate Order;
- 1.1.11. “Financial Default” in respect of a Party means a failure by that Party to pay an amount to the other Party when due under this Agreement, including failure to pay compensation or indemnification for loss or damage agreed to by the Parties or for amounts determined to be owed to a Party as a result of the settlement or resolution of a dispute arising under this Agreement;
- 1.1.12. “Force Majeure Event” in respect of a Party means any event or circumstance, or combination of events or circumstances: (a) that is beyond the reasonable control of that Party; (b) that adversely affects the performance by the Party of its obligations under this

Agreement; and (c) the adverse effects of which could not have been foreseen and prevented, overcome, remedied or mitigated in whole or in part by the Party through the exercise of due diligence and reasonable care, provided however that the lack, insufficiency or non-availability of funds shall not constitute a Force Majeure Event;

1.1.13. "Insolvency/Dissolution Event" in respect of a Party, means any of the following:

- (a) in the case of a voluntary insolvency/dissolution, if the Party shall (i) apply for or consent to the appointment of a receiver, receiver/manager, interim receiver, trustee, administrator, or liquidator (or person having a similar or analogous function under the laws of any jurisdiction) of itself or of all or a substantial part of its assets; (ii) be unable, or state or admit in writing its inability or failure, to pay its debts generally as they become due; (iii) make a general assignment for the benefit of its creditors, or make or threaten to make a sale in bulk of all or a substantial part of its assets; (iv) commit an act of bankruptcy under the *Bankruptcy and Insolvency Act* (Canada) or under any existing or future law relating to bankruptcy and insolvency; (v) commence any proceeding or other action under any existing or future law relating to bankruptcy, insolvency, reorganization, or relief of debtors seeking to have an order for relief entered with respect to it, or seeking to adjudicate it bankrupt or insolvent, or seeking reorganization, arrangement, adjustment, moratorium, winding up, liquidation, dissolution, composition, compromise or other relief with respect to it or its debts or an arrangement with creditors, or file an answer admitting the material allegations filed against it in any bankruptcy, insolvency, or reorganization proceeding; or (vi) take any corporate action for the purpose of effecting any of (i) to (v);
- (b) in the case of an involuntary insolvency/dissolution, if any proceeding or other action shall be instituted in any court of competent jurisdiction seeking in respect of the Party or of all or a substantial part of its assets (i) an adjudication in bankruptcy or for reorganization, dissolution, winding up or liquidation; (ii) a composition, compromise, arrangement or moratorium with its creditors, or other relief with respect to it or its debts; (iii) the appointment of a trustee, receiver, receiver/manager, interim receiver, administrator or liquidator (or person having a similar or analogous function under the laws of any jurisdiction); or (iv) any other similar relief under any existing or future law relating to bankruptcy, insolvency, reorganization or relief of debtors;
- (c) an application is made for the winding up or dissolution or a resolution is passed or any steps are taken to pass a resolution for the winding up or dissolution of the Party, except as part of a bona fide corporate reorganization; or
- (d) the Party is wound up or dissolved, except as part of a bona fide corporate reorganization, unless the notice of winding up or dissolution is discharged;

- 1.1.14. “Lender” in respect of a Customer means a bank or other entity whose principal business is that of a financial institution and that is financing or refinancing the Customer’s facilities;
- 1.1.15. “Non-defaulting Party” means a Party that is not experiencing an Event of Default;
- 1.1.16. “Non-financial Default” in respect of a Party means any of the following:
- (a) any breach of this Agreement by that Party, other than a breach that constitutes a Financial Default;
  - (b) the licence (if any) of the Party is suspended, withdrawn or revoked or expires without being replaced; or
  - (c) an Insolvency/Dissolution Event occurs in relation to the Party;
- 1.1.17. “Party Losses” means any claims, losses, costs, liabilities, obligations, actions, judgments, suits, expenses, disbursements or damages of a Party, including where occasioned by a judgment resulting from an action instituted by a third party;
- 1.1.18. “Rate Schedule” means the rates in effect from time to time and the terms and conditions relating to those rates that are approved by the Board in the Transmitter’s Rate Order, including rates for connection service;
- 1.1.19. “Schedule” means a schedule listed in section 4.2.1 and any additional schedules created by the Parties under section 4.3.1;
- 1.1.20. “Supporting Guarantee” means operating instructions, such as instructions to open or close a switch or to lock devices in the open position, given to protect the safety of staff and the public while work is being performed by a Party; and
- 1.1.21. “Work Protection” means a state or condition whereby an isolated or isolated and de-energized condition has been established for work on facilities and will continue to exist, except for authorized tests, until the work relating thereto has been completed.
- 1.2. In this Agreement, unless the context otherwise requires, each of the following words and phrases shall have the meaning given to it in the Code (whether or not capitalized in the Code or in this Agreement): “Board”; “business day”; “Code revision date”; “connect”; “connection facilities”; “connection point”; “connection service”; “contracted capacity”; “circuit breaker”; “emergency”; “facilities”; “fault”; “forced outage”; “good utility practice”; “isolate”; “isolating device”; “licence”; “maintenance”; “outage”; “planned outage”; “promptly”; “protection system”; “protective relay”; “Rate Order”; “reliability”; “reliability organization”; “reliability standards”; “single contingency”; “site”; “transmission facilities”; “transmission service”; “transmission system” and “work”.

## 2. INTERPRETATION

- 2.1. Words and phrases contained in this Agreement (whether or not capitalized) that are not defined herein shall have the meanings given to them in the *Electricity Act, 1998*, S.O. 1998, c. 15, Schedule A, the *Ontario Energy Board Act, 1998*, S.O. 1998, c. 15, Schedule B, or in any regulations made under either of those *Acts*, as the case may be.
- 2.2. Headings are for convenience only and shall not affect the interpretation of this Agreement.
- 2.3. In this Agreement, unless the context otherwise requires:
  - (a) words importing the singular include the plural and vice versa;
  - (b) words importing a gender include any gender;
  - (c) words importing a person include: (a) an individual, (b) a company, sole proprietorship, partnership, trust, joint venture, association, corporation or other private or public body corporate; and (c) any government, government agency or body, regulatory agency or body or other body politic or collegiate;
  - (d) a reference to a person includes that person's successors and permitted assigns;
  - (e) a reference to a Party includes any person acting on behalf of that Party;
  - (f) a reference to the Customer's facilities is limited to such facilities as are relevant to the Customer's connection to the Transmitter's transmission system under this Agreement;
  - (g) a reference to a body, whether statutory or not, that ceases to exist or whose functions are transferred to another body is a reference to the body that replaces it or that substantially succeeds to its powers or functions;
  - (h) a reference to a document (including a statutory instrument) or a provision of a document includes any amendment or supplement to, or any replacement of, that document or that provision;
  - (i) the expression "including" means including without limitation, and the expressions "include", "includes" and "included" shall be interpreted accordingly; and
  - (j) where a word or phrase is defined in this Agreement, including by virtue of the application of section 1.2, or in any document referred to in section 2.1, other parts of speech and grammatical forms of the word or phrase have a corresponding meaning.



2.4. Except when an emergency is anticipated or is occurring, if the time for doing any act or omitting to do any act under this Agreement expires on a day that is not a business day, the act may be done or may be omitted to be done on the next day that is a business day.

### **3. INCORPORATION OF TRANSMISSION SYSTEM CODE**

3.1 The Code is hereby incorporated in its entirety by reference into, and forms an integral part of, this Agreement. Unless the context otherwise requires, all references in this Agreement to “this Agreement” shall be deemed to include a reference to the Code.

3.2. Without limiting the generality of section 3.1:

- (a) the Transmitter hereby agrees to be bound by, and at all times to comply with, the Code; and
- (b) the Customer acknowledges and agrees that the Transmitter is bound at all times to comply with the Code in addition to complying with the provisions of this Agreement.

### **4. SCHEDULES**

#### **4.1. Incorporation of Schedules**

4.1.1. The Schedules form a part of, and are hereby incorporated by reference into, this Agreement.

#### **4.2. Schedules**

4.2.1 The following are the Schedules to this Agreement:

- Schedule A - Single Line Diagram, Description of the Customer’s Connection Point(s) and Details of Specific Operations
- Schedule B - Transmission Services and Associated Charges  
- Attachment B1
- Schedule C - Cure Periods for Defaults
- Schedule D - Fault Levels and Modifications Requiring Transmitter Approval  
- Attachment D1
- Schedule E - General Technical Requirements
- Schedule F - Additional Technical Requirements
- Schedule G - Protection System Requirements
- Schedule H - Facilities Deemed Compliant and Obligation to Comply
- Schedule I - Exchange of Information
- Schedule J - Contacts for Purposes of Notice
- Schedule K - Special Provisions

#### **4.3. Additional Schedules**

- 4.3.1. The Parties may by mutual agreement append such additional Schedules to this Agreement as may from time to time be required. Where additional Schedules are required by virtue of the fact that technical requirements for load facilities owned by the Customer are relevant to the Customer's connection to the Transmitter's transmission system under this Agreement, the Parties shall use schedules in the form set out in schedules E and F of version A of the connection agreement set out in Appendix 1 of the Code.
- 4.3.2. In the event of an inconsistency or conflict between a provision of an additional Schedule referred to in section 4.3.1 and a provision of this Agreement or of a Schedule referred to in section 4.2.1, the provision of this Agreement or of the Schedule referred to in section 4.2.1 shall prevail to the extent of the inconsistency or conflict.

## **5. NOTICE**

### **5.1. Method of Giving Notice and Effective Date**

- 5.1.1. Subject to section 5.1.3, any notice, demand, consent, request or other communication required or permitted to be given or made under or in relation to this Agreement shall be given or made by courier or other personal form of delivery; by registered mail; by facsimile; or by electronic mail.
- 5.1.2. A notice, demand, consent, request or other communication referred to in section 5.1.1 shall be deemed to have been duly given or made as follows:
- (a) where given or made by courier or other form of personal delivery, on the date of receipt;
  - (b) where given or made by registered mail, on the sixth day following the date of mailing;
  - (c) where given or made by facsimile and a complete transmission report is issued from the sender's facsimile transmission equipment, on the day and at the time of transmission as indicated on the sender's facsimile transmission report, if a business day or, if the transmission is on a day which is not a business day or is after 5:00 pm (addressee's time), at 9:00 am on the following business day; and
  - (d) where given or made by electronic mail, on the day and at the time when the notice, demand, consent, request or other communication is recorded by the sender's electronic communications system as having been received at the electronic mail destination, if a business day, or if that time is after 5:00 pm (addressee's time) or that day is not a business day, at 9:00 am on the following business day.

5.1.3. Any notice, demand, consent, request or other communication required or permitted to be given or made under Schedule A shall be given or made in accordance with the notice provisions contained in that Schedule.

## **5.2. Address for Notice**

5.2.1. Any notice, demand, consent, request or other communication given or made under section 5.1.1 shall be addressed to the applicable representative of the Party identified in Schedule J. A Party may, upon written notice given to the other Party in accordance with section 5.1.1, from time to time change its address or representative for notice, and Schedule J shall be deemed to have been amended accordingly.

5.2.2. Any notice, demand, consent, request or other communication given or made under section 5.1.3 shall be addressed in accordance with Schedule A.

## **5.3. Exception**

5.3.1. Sections 5.1 and 5.2 are subject to such other provisions of this Agreement that expressly require or permit notices, demands, consents, requests or other communications to be given or made by alternative means or to be addressed to other specified representatives of the Parties.

## **6. ASSIGNMENT**

6.1. Subject to section 6.2, no Party may assign or transfer, whether absolutely, by way of security or otherwise, all or any part of its rights or obligations under this Agreement without the prior written consent of the other Party, which consent may not be unreasonably withheld or delayed.

6.2. The Customer may, without the prior written consent of the Transmitter, assign by way of security only all or any part of its rights or obligations under this Agreement to a Lender. The Customer shall promptly notify the Transmitter upon making any such assignment.

## **7. FURTHER ASSURANCES**

7.1. Each Party shall promptly execute and deliver or cause to be executed and delivered all further documents in connection with this Agreement that the other Party may reasonably require for the purposes of giving effect to this Agreement.

## **8. WAIVER**

- 8.1. A waiver of any default, breach or non-compliance under this Agreement is not effective unless in writing and signed by the Party to be bound by the waiver. No waiver will be inferred or implied by any failure to act or by the delay in acting by a Party in respect of any default, breach or non-compliance or by anything done or omitted to be done by the other Party. The waiver by a Party of any default, breach or non-compliance under this Agreement shall not operate as a waiver of that Party's rights under this Agreement in respect of any continuing or subsequent default, breach or non-compliance, whether of the same or any other nature.

## **9. AMENDMENTS**

- 9.1. The Parties may not amend this Agreement without leave of the Board, except where and to the extent expressly permitted by this Agreement.
- 9.2. The Parties may by mutual agreement amend this Agreement to reflect changes that may from time to time be made to the Code during the term of this Agreement.
- 9.3. The Parties may, by mutual agreement unless this Agreement otherwise provides, amend the following Schedules:
- (a) Schedule A;
  - (b) Schedule B, to reflect any changes to the Transmitter's Rate Order that may from time to time come into effect and in relation to Attachment B1;
  - (c) Schedule D, including Attachment D1;
  - (d) Schedule H, in relation to section H.1;
  - (e) Schedule I;
  - (f) Schedule J; and
  - (g) any Schedule added by the Parties under section 4.3.1.
- 9.4. The Parties shall amend this Agreement in such manner as may be required by the Board.
- 9.5. Any amendment to this Agreement shall be made in writing and duly executed by the Parties.
- 9.6. In the event of an inconsistency or conflict between a provision of an amendment to a Schedule made under section 9.3, other than an amendment made under section 9.4, and a provision of this Agreement, the provision of this Agreement shall prevail to the extent of the inconsistency or conflict.

9.7. In the event of an inconsistency or conflict between a provision of an amendment to this Agreement, other than an amendment made under section 9.4, and a provision of the Code, the provision of the Code shall prevail to the extent of the inconsistency or conflict.

## **10. SUCCESSORS AND ASSIGNS**

10.1. This Agreement shall enure to the benefit of, and be binding on, the Parties and their respective successors and permitted assigns.

## **11. ENTIRE AGREEMENT**

11.1. Except as expressly provided herein, this Agreement, together with the Schedules, constitutes the entire agreement between the Parties and supersedes all prior oral or written representations and agreements of any kind whatsoever with respect to the subject-matter hereof.

## **12. GOVERNING LAW**

12.1. This Agreement shall be governed by and construed in accordance with the laws of the Province of Ontario and the federal laws of Canada applicable therein.

## **13. COUNTERPARTS**

13.1. This Agreement may be executed in any number of counterparts, each of which shall be deemed to be an original and all of which taken together shall be deemed to constitute one and the same instrument. Counterparts may be executed either in original or faxed form and the Parties shall adopt any signatures received by a receiving facsimile machine as original signatures of the Parties; provided, however, that any Party providing its signature in such manner shall promptly forward to the other Party an original signed copy of this Agreement which was so faxed.

## PART TWO

### REPRESENTATIONS AND WARRANTIES

#### 14. REPRESENTATIONS AND WARRANTIES

##### 14.1. Customer's Representations and Warranties

14.1.1. Subject to section 14.3.1, the Customer represents and warrants to the Transmitter as follows, and acknowledges and confirms that the Transmitter is relying on such representations and warranties without independent inquiry in entering into this Agreement:

- (a) it is duly incorporated, formed or registered (as applicable) under the laws of its jurisdiction of incorporation, formation or registration (as applicable);
- (b) it has all the necessary corporate power, authority, and capacity to enter into this Agreement and to perform its obligations hereunder;
- (c) the execution, delivery and performance of this Agreement by it has been duly authorized by all necessary corporate and/or governmental and/or other organizational action and does not (or would not with the giving of notice, the lapse of time or the happening of any other event or condition) result in a violation or a breach of or a default under or give rise to a right of termination, greater rights or increased costs, amendment or cancellation or the acceleration of any obligation under (i) any charter or by-law instruments of the Customer; (ii) any contracts or instruments to which the Customer is bound; or (iii) any laws applicable to it;
- (d) any individual executing this Agreement and any document in connection herewith, on behalf of the Customer has been duly authorized to execute this Agreement and has the full power and authority to bind the Customer;
- (e) this Agreement constitutes a legal and binding obligation on the Customer, enforceable against the Customer in accordance with its terms;

- (f) other than the facilities listed in Schedule H, its facilities meet the technical requirements of this Agreement; and
- (g) it holds all permits, licences and other authorizations that may be necessary to enable it to carry on its business.

14.1.2. The Customer shall promptly notify the Transmitter of any circumstance that does or may result in any of the representations and warranties set forth in section 14.1.1 becoming untrue or inaccurate during the term of this Agreement.

## **14.2. Transmitters' Representations and Warranties**

14.2.1. Subject to section 14.3.1, the Transmitter represents and warrants to the Customer as follows, and acknowledges and confirms that the Customer is relying on such representations and warranties without independent inquiry in entering into this Agreement:

- (a) it is duly incorporated, formed or registered (as applicable) under the laws of its jurisdiction of incorporation, formation or registration (as applicable);
- (b) it has all the necessary corporate power, authority, and capacity to enter into this Agreement and to perform its obligations hereunder;
- (c) the execution, delivery and performance of this Agreement by it has been duly authorized by all necessary corporate and/or governmental and/or other organizational action and does not (or would not with the giving of notice, the lapse of time or the happening of any other event or condition) result in a violation or a breach of or a default under or give rise to a right of termination, greater rights or increased costs, amendment or cancellation or the acceleration of any obligation under (i) any charter or by-law instruments of the Transmitter; (ii) any contracts or instruments to which the Transmitter is bound; or (iii) any laws applicable to it;
- (d) any individual executing this Agreement, and any document in connection herewith, on behalf of the Transmitter has been duly authorized to execute this Agreement and has the full power and authority to bind the Transmitter;
- (e) this Agreement constitutes a legal and binding obligation on the Transmitter, enforceable against the Transmitter in accordance with its terms;

- (f) other than the facilities listed in Schedule H, those of its facilities that are relevant to, or may have an impact on, the Customer's facilities meet the technical requirements of this Agreement; and
- (g) it holds all permits, licences and other authorizations that may be necessary to enable it to carry on its business as a Transmitter.

14.2.2. The Transmitter shall promptly notify the Customer of any circumstance that does or may result in any of the representations and warranties set forth in section 14.2.1 becoming untrue or inaccurate during the term of this Agreement.

### **14.3. Transition**

14.3.1. Where the provisions of this Agreement apply by virtue of the application of section 3.0.7 of the Code, the representations and warranties referred to in sections 14.1.1(f) and 14.2.1(f) shall be deemed to be given only once the parties have completed sections H.1.1 and H.1.2 of Schedule H.



## **PART THREE**

### **LIABILITY AND FORCE MAJEURE**

#### **15. LIABILITY**

- 15.1. Except as otherwise expressly provided in this Agreement, the Transmitter shall not be liable for any Party Losses of the Customer whatsoever arising out of any act or omission of the Transmitter under this Agreement unless such Party Losses result from the willful misconduct or negligence of the Transmitter.
- 15.2. Subject to section K.1 of Schedule K and except as otherwise expressly provided in this Agreement, the Customer shall not be liable for any Party Losses of the Transmitter whatsoever arising out of any act or omission of the Customer under this Agreement unless such Party Losses result from the willful misconduct or negligence of the Customer.
- 15.3. Despite sections 15.1 and 15.2 but except as otherwise expressly provided in sections 21.4, 27.13.6, 27.13.7 and 27.13.9, neither Party shall be liable to the other, whether as claims in contract or in tort or otherwise, for any loss of profits or revenues, business interruption losses, loss of contract or loss of goodwill, or for any indirect, consequential, incidental or special damages, including punitive or exemplary damages.
- 15.4. A Party shall have a duty to mitigate any Party Losses relating to any claim for indemnification from the other Party that may be made in relation to that other Party. Nothing in this section 15.4 shall require the mitigating Party to mitigate or alleviate the effects of any strike, lockout, restrictive work practice or other labour dispute.
- 15.5. A Party shall give prompt notice to the other Party of any claim with respect to which indemnification is being or may be sought under this Agreement.

#### **16. FORCE MAJEURE**

- 16.1. No Liability Where Force Majeure Event **Occurs**
- 16.1.1. Subject to sections 16.1.2 to 16.1.4, a Party shall not be liable to the other Party for any failure or delay in the performance of any of its obligations under this Agreement in whole or in part to the extent that such failure or delay is due to a Force Majeure Event.
- 16.1.2. The Party invoking a Force Majeure Event shall only be excused from performance under section 16.1.1:

- (a) for so long as the Force Majeure Event continues and for such reasonable period of time thereafter as may be necessary for the Party to resume performance of the obligation; and
- (b) where and to the extent that the failure or delay in performance would not have been experienced but for such Force Majeure Event.

16.1.3. Nothing in this section 16 shall excuse a Party from performing any of their respective emergency-related obligations in the event of an emergency.

16.1.4. A Party may not invoke a Force Majeure Event unless it has given notice in accordance with section 16.2.

## **16.2. Obligations Where Force Majeure Event Occurs**

16.2.1. Where a Party invokes a Force Majeure Event, it shall promptly give notice to the other Party, which notice shall include particulars of:

- (a) the nature of the Force Majeure Event and, if known, of its duration;
- (b) the effect that the Force Majeure Event is having on the Party's performance of its obligations under this Agreement; and
- (c) the measures that the Party is taking, or proposes to take, to alleviate the impact of the Force Majeure Event.

Such notice may be given verbally, in which case the notifying Party shall as soon as practicable thereafter confirm the notice in writing.

16.2.2. Where a Party invokes a Force Majeure Event, it shall use all reasonable endeavours to mitigate or alleviate the effects of the Force Majeure Event on the performance of its obligations under this Agreement. Nothing in this section 16.2.2 shall require the mitigating Party to mitigate or alleviate the effects of any strike, lockout, restrictive work practice or other labour dispute.

16.2.3. Where a Party invokes a Force Majeure Event, it shall notify the other Party in writing as soon as practicable of the cessation of the Force Majeure Event and of the cessation of the effects of the Force Majeure Event on the Party's performance of its obligations under this Agreement.

**PART FOUR**  
**DISPUTE RESOLUTION**

**17. DISPUTE RESOLUTION**

**17.1. Exclusivity**

17.1.1. Subject to sections 17.1.2 and 17.1.3:

- (a) the dispute resolution procedure set forth in this section 17 shall apply to all disputes between the Customer and the Transmitter arising under or in relation to this Agreement; and
- (b) the Parties shall comply with the procedure set out in this section 17 before taking any other civil or other proceeding in relation to the dispute.

17.1.2. Nothing in section 17.1.1 shall prevent a Party from seeking urgent or interlocutory relief from a court of competent jurisdiction in the Province of Ontario in relation to any dispute between them arising under or in relation to this Agreement.

17.1.3. The dispute resolution procedure set forth in this section 17 shall not apply:

- (a) in relation to any matter that must or may be submitted to the Board for resolution under section 4.7.1, 6.1.8, 6.2.20, 6.2.27, 6.3.5 or 6.3.11(c) of the Code or section K.2.2 of Schedule K; or
- (b) in relation to any dispute to be resolved under the Market Rules as described in section B.6 of Schedule B.

**17.2. Duty to Negotiate**

17.2.1. Any dispute between the Customer and the Transmitter referred to in section 17.1.1 shall be referred to a designated senior representative of each of the Parties for resolution on an informal basis as quickly as possible.

17.2.2. The designated senior representatives of the Parties shall attempt in good faith to resolve the dispute within thirty days of the date on which the dispute was referred to them. The Parties may by mutual agreement extend such period.

- 17.2.3. If a dispute is settled by the designated senior representatives of the Parties, the Parties shall prepare and execute minutes setting forth the terms of the settlement. Such terms shall bind the Parties. The subject-matter of the dispute shall not thereafter be the subject of any civil or other proceeding, other than in relation to the enforcement of the terms of the settlement.
- 17.2.4. If a Party fails to comply with the terms of settlement referred to in section 17.2.3, the other Party may submit the matter to arbitration under section 17.3.1.
- 17.2.5. A copy of the minutes referred to in section 17.2.3 from which all Confidential Information has been expunged shall be made available to the public by the Transmitter.
- 17.2.6. The Parties may not, by means of the settlement of a dispute under section 17.2.3 or section 17.5.10, agree to terms or conditions that would, if they had been the subject of an amendment to this Agreement, violate section 9.1.

### **17.3. Submission of Unresolved Disputes to Arbitration**

- 17.3.1. If the designated senior representatives of the Parties cannot resolve the dispute within the time period set out in section 17.2.2 or where section 17.2.4 or 17.5.11 applies, either Party may submit the dispute to binding arbitration under sections 17.4 and 17.5 by notice to the other Party.

### **17.4. Selection of Arbitrator(s)**

- 17.4.1. The Parties shall use good faith efforts to appoint a single arbitrator for purposes of the arbitration of the dispute. If the Parties fail to agree upon a single arbitrator within ten business days of the date of the notice referred to in section 17.3.1, each Party shall within five business days thereafter choose one arbitrator. The two arbitrators so chosen shall within twenty days select a third arbitrator.
- 17.4.2. Where a Party has failed to choose an arbitrator under section 17.4.1 within the time allowed, the other Party may apply to a court to appoint a single arbitrator to resolve the dispute.
- 17.4.3. No person shall be appointed as an arbitrator unless that person:
- (a) is independent of the Parties;
  - (b) has no current or past substantial business or financial relationship with either Party, except for prior arbitration; and
  - (c) is qualified by education or experience to resolve the dispute.

## 17.5. Arbitration Procedure

- 17.5.1 The arbitrator(s) shall provide each of the Parties with an opportunity to be heard orally and/or in writing, as may be appropriate to the nature of the dispute.
- 17.5.2. The *Arbitration Act, 1991* (Ontario) shall apply to an arbitration conducted under this section 17.
- 17.5.3. The arbitrator(s) shall make due provision for the adequate protection of Confidential Information that may be disclosed or may be required to be produced during the course of an arbitration in a manner consistent with the confidentiality obligations of section 21.
- 17.5.4. All proceedings relating to the arbitration of a dispute shall be conducted in private unless the Parties agree otherwise.
- 17.5.5. Unless the Parties otherwise agree, the arbitrator(s) shall render a decision within ninety days of the date of appointment of the last to be appointed arbitrator, and shall notify the Parties of the decision and of the reasons therefore.
- 17.5.6. The decision of the arbitrator(s) shall be final and binding on the Parties and may be enforced in accordance with the provisions of the *Arbitration Act, 1991* (Ontario). The Party against which the decision is enforced shall bear all costs and expenses reasonably incurred by the other Party in enforcing the decision.
- 17.5.7. A copy of the decision of the arbitrator(s) from which all Confidential Information has been expunged shall be made available to the public by the Transmitter.
- 17.5.8. Subject to section 17.5.9, each Party shall be responsible for its own costs and expenses incurred in the arbitration of a dispute and for the costs and expenses of the arbitrator(s) if appointed to resolve the dispute.
- 17.5.9. The arbitrator(s) may, if the arbitrator(s) consider it just and reasonable to do so, make an award of costs against or in favour of a Party to the dispute. Such an award of costs may relate to either or both the costs and expenses of the arbitrator(s) and the costs and expenses of the Parties to the dispute.
- 17.5.10. If a dispute is settled by the Parties during the course of an arbitration, the Parties shall prepare and execute minutes setting forth the terms of the settlement. Such terms shall bind the Parties, and either Party may request that the arbitrator(s) record the settlement in the form of an award under section 36 of the *Arbitration Act, 1991* (Ontario). The subject-matter of the dispute shall not thereafter be the subject of any civil or other proceeding, other than in relation to the enforcement of the terms of the settlement.

- 17.5.11. If a Party fails to comply with the terms of settlement referred to in section 17.5.10, the other Party may submit the matter to arbitration under section 17.3.1 if the settlement has not been recorded in the form of an award under section 36 of the *Arbitration Act, 1991* (Ontario).
- 17.5.12. A copy of the minutes referred to in section 17.5.10 from which all Confidential Information has been expunged shall be made available to the public by the Transmitter.

## **PART FIVE**

### **TERM, TERMINATION AND EVENTS OF DEFAULT**

#### **18. TERM AND TERMINATION**

##### **18.1. Coming into Force**

18.1.1. Subject to section 18.1.2, this Agreement shall come into force on the date first mentioned above and shall remain in full force and effect until terminated in accordance with this Agreement.

18.1.2. Where the provisions of this Agreement apply by virtue of the application of section 3.0.7 of the Code, those provisions shall come into force on the Code revision date and shall remain in full force and effect until terminated in accordance with this Agreement.

##### **18.2. Termination Without Cause by Customer**

18.2.1. The Customer may, if it is not then a Defaulting Party to whom a Default Notice has been delivered, terminate this Agreement at any time during the term of this Agreement by giving the Transmitter six months' prior written notice setting out the termination date.

18.2.2. Where the Customer gives notice to terminate under section 18.2.1, the Transmitter shall disconnect all of the Customer's facilities at all connection points on the termination date specified in that notice or on such other date as the Parties may agree in writing.

18.2.3. Section 20.5 shall apply in relation to the disconnection of the Customer's facilities under section 18.2.2.

##### **18.3. Termination for Cause by Either Party**

18.3.1. Termination of this Agreement by a Party by reason of an Event of Default occurring in relation to the other Party shall be effected in accordance with section 19.

##### **18.4. Provisions Relating to Termination Generally**

18.4.1. Termination of this Agreement for any reason shall not affect:

- (a) the liabilities of either Party that were incurred or arose under this Agreement prior to the time of termination; or
- (b) that expressly apply in relation to disconnection of the Customer's facilities following termination of this Agreement.

18.4.2. Termination of this Agreement for any reason shall be without prejudice to the right of

the terminating Party to pursue all legal and equitable remedies that may be available to it, including injunctive relief.

## **18.5. Rights and Remedies not Exclusive**

18.5.1. The rights and remedies set out in this Agreement are not intended to be exclusive but rather are cumulative and are in addition to any other right or remedy otherwise available to a Party at law or in equity.

18.5.2. Nothing in this section 18.5 shall be interpreted as affecting the limitations of liability set forth in section 15 or the obligation of a Party to comply with section 17 while this Agreement is in force.

## **18.6. Survival**

18.6.1. Sections 18.4 and 18.5 shall survive termination of this Agreement.

## **19. EVENTS OF DEFAULT AND TERMINATION FOR CAUSE**

### **19.1. Occurrence of an Event of Default**

19.1.1. If an Event of Default occurs in relation to a Party, the Non-defaulting Party may, without prejudice to its other rights and remedies as provided for in this Agreement or at law or in equity, serve the Defaulting Party with a notice specifying the Event of Default that has occurred and the applicable Cure Period (“Default Notice”).

### **19.2. Curing Events of Default**

19.2.1. Upon receipt of a Default Notice, the Defaulting Party shall be entitled to remedy the Event of Default specified in the Default Notice:

- (a) for a Financial Default, within the applicable Cure Period specified in Schedule C, calculated from the date of receipt of the Default Notice;
- (b) for a Non-financial Default that has an impact that is referred to in Schedule C, within the applicable Cure Period specified for that impact in Schedule C, calculated from the date of the receipt of the Default Notice; or
- (c) for a Non-financial Default that does not have an impact that is referred to in Schedule C, within a period of twenty business days from the date of receipt of the Default Notice.

The Parties may agree to a Cure Period that is longer than the Cure Period that would otherwise apply under section 19.2.1(a), 19.2.1(b) or 19.2.1(c).



19.2.2. During the Cure Period, the Defaulting Party shall diligently seek to remedy the Event of Default specified in the Default Notice.

19.2.3. If the Non-defaulting Party considers that the Defaulting Party is not, during the Cure Period, diligently seeking to remedy a Non-financial Default, the Non-defaulting Party may serve the Defaulting Party with a notice (“End of Cure Period Notice”) to that effect. If, within ten business days of receiving the End of Cure Period Notice, the Defaulting Party has not commenced to diligently seek to remedy the Non-financial Default, the Cure Period shall end on the fifth business day following the date of receipt of the End of Cure Period Notice, and section 19.3.1 shall apply.

19.2.4. A Financial Default shall be considered remedied when:

- (a) the Defaulting Party has paid to the Non-defaulting Party all amounts specified in the Default Notice, together with interest calculated in accordance with section 19.2.5; and
- (b) the Defaulting Party has reimbursed the Non-defaulting Party for all costs of enforcement, recovery, or attempted enforcement or recovery, including reasonable legal costs and expenses, reasonably incurred by the Non-defaulting Party in relation to the Financial Default.

19.2.5. Amounts specified in a Default Notice given in relation to a Financial Default shall bear interest at the prime lending rate set by the Bank of Canada plus two percent from the date on which the Event of Default occurred until the date on which payment is sent to the Non-defaulting Party.

19.2.6. A Non-financial Default shall be considered remedied when:

- (a) the Event of Default has been remedied to the reasonable satisfaction of the Non-defaulting Party; and
- (b) the Defaulting Party has reimbursed the Non-defaulting Party for all costs of enforcement or recovery or attempted enforcement or recovery, including reasonable legal costs and expenses, reasonably incurred by the Non-defaulting Party in relation to the Non-financial Default.

### **19.3. Right to Terminate and Disconnect**

19.3.1. Subject to section 19.3.2, where an Event of Default has not been remedied prior to the expiry of the applicable Cure Period, including in accordance with section 19.2.3, the Non-defaulting Party may, without prejudice to its other rights and remedies as provided for in this Agreement or at law or in equity, terminate this Agreement by written notice to the Defaulting Party. Such termination shall take effect:

- (a) in the case of a Non-financial Default, on the date on which the termination notice

- is delivered to the Defaulting Party; or
- (b) in the case of a Financial Default, on the date that is seven business days from the date on which the termination notice is delivered to the Defaulting Party.

19.3.2. The Transmitter may not terminate this Agreement under section 19.3.1 or, subject to section 19.3.5, disconnect the Customer's facilities under section 19.3.3 in relation to an Event of Default by the Customer where the issue of the Customer's default has been referred to the dispute resolution process referred to in section 17 and the dispute has not been finally resolved.

19.3.3. The Transmitter may disconnect all of the Customer's facilities at all applicable connection points on or after the date on which this Agreement terminates under section 19.3.1.

19.3.4. Section 20.5 shall apply in relation to the disconnection of the Customer's facilities under section 19.3.3.

19.3.5. Nothing in this section 19 shall prevent the Transmitter from:

- (a) disconnecting the Customer's facilities where permitted by section 20.3.1, even if the Customer is a Defaulting Party at the relevant time; or
- (b) immediately disconnecting the Customer's facilities where the Transmitter reasonably believes that a Non-financial Default by the Customer is having or will have a material adverse effect on the Transmitter's transmission system or on a third party.

#### **19.4. Lender's Right of Substitution**

19.4.1. Where a Default Notice has been served on the Customer, an agent or trustee for and on behalf of a Lender ("Security Trustee") or a receiver appointed by the Security Trustee ("Receiver") shall upon notice to the Transmitter be entitled (but not obligated) to exercise all of the rights and obligations of the Customer under this Agreement and shall be entitled to remedy the Event of Default specified in the Default Notice within the applicable Cure Period. The Transmitter shall accept performance of the Customer's obligations under this Agreement by the Security Trustee or Receiver in lieu of the Customer's performance of such obligations, and will not exercise any right to terminate this Agreement under section 19.3.1 due to an Event of Default if the Security Trustee, its nominee or transferee, or the Receiver acknowledges its intention to be bound by the terms of this Agreement and such acknowledgment is received within 30 days of the date of receipt by the Customer of the Default Notice.

## PART SIX

### DISCONNECTION AND RECONNECTION

#### **20. DISCONNECTION**

##### **20.1. Voluntary Permanent Disconnection by Customer**

- 20.1.1. The Customer may at any time voluntarily and permanently disconnect some but not all of its facilities from the Transmitter's transmission facilities provided that the Customer is not then a Defaulting Party to whom a Default Notice has been delivered.
- 20.1.2. The Customer shall give the Transmitter notice in writing of its intention to voluntarily disconnect some of its facilities under section 20.1.1 no less than ten days before the date on which the Customer wishes to disconnect.
- 20.1.3. Section 20.5 shall apply in relation to the disconnection of the Customer's facilities under section 20.1.1.

##### **20.2. Voluntary Temporary Disconnection by Customer and Reconnection**

- 20.2.1. Where practical, the Customer shall notify the Transmitter prior to temporarily disconnecting its facilities from the Transmitter's transmission system.
- 20.2.2. The Transmitter shall, at the Customer's request, reconnect the Customer's facilities to its transmission system following a voluntary temporary disconnection under section 20.2.1 once the Transmitter is reasonably satisfied that all requirements of this Agreement are met, that all payments due to be paid by the Customer under this Agreement have been made and that the Customer agrees to pay all reasonable reconnection costs charged by the Transmitter. Reconnection shall be effected in accordance with the Transmitter's Board-approved reconnection procedures referred to in section 6.10.3 of the Code or, in the absence of such procedures, in accordance with the procedures agreed between the Parties.

##### **20.3. Disconnection by Transmitter**

- 20.3.1. The Transmitter may disconnect the Customer's facilities at any connection point and at any time throughout the term of this Agreement in any of the following circumstances:
- (a) in accordance with subsection 40 (5) of the *Electricity Act, 1998*, other applicable law, the Transmitter's licence or the Market Rules;
  - (b) where required to comply with a decision or order of an arbitrator or court made or given under section 17;

- (c) during an emergency or where necessary to prevent or minimize the effects of an emergency; or
- (d) where required by an order or direction from the IESO given in accordance with the Market Rules.

20.3.2. Section 20.5 shall, to the extent applicable, apply in relation to the disconnection of the Customer's facilities under section 20.3.1.

#### **20.4. Reconnection after Disconnection by Transmitter**

20.4.1. Where a Customer's facilities have been disconnected under section 20.3 during an emergency, the Transmitter shall reconnect the Customer's facilities to its transmission facilities when it is reasonably satisfied that the emergency has ceased and that all other requirements of this Agreement are met.

20.4.2. Where a Customer's facilities have been disconnected under section 20.3 other than during an emergency, the Transmitter shall reconnect the Customer's facilities to its transmission system when it is reasonably satisfied that the reason for the disconnection no longer exists, the Customer agrees to pay all reasonable reconnection costs charged by the Transmitter, and the Transmitter is reasonably satisfied of the following, where applicable:

- (a) the Customer has taken all necessary steps to prevent the circumstances that caused the disconnection from recurring and has delivered binding undertakings to the Transmitter that such circumstances shall not recur; and
- (b) any decision or order of a court or arbitrator made or given under section 17 that requires a Party to take action to ensure that such circumstances shall not recur has been implemented and/or assurances have been given to the satisfaction of the affected Party that such decision or order will be implemented.

20.4.3. Reconnection under this section 20.4 shall be effected in accordance with the Transmitter's Board-approved reconnection procedures referred to in section 6.10.3 of the Code or, in the absence of such procedures, in accordance with the procedures agreed between the Parties.

#### **20.5. Provisions Applicable to Disconnection Generally**

20.5.1. Within 20 business days of the coming into force of this Agreement, the Parties shall develop appropriate operating and decommissioning procedures for the Customer's facilities. The Parties shall comply with those operating and decommissioning procedures in relation to any disconnection of the Customer's facilities.

- 20.5.2. Where the Customer's facilities are disconnected, each Party shall be entitled to decommission and remove its assets associated with the connection and the applicable connection points. Each Party shall, for that purpose, provide the other Party with all necessary access to its site at all reasonable times.
- 20.5.3. The Customer shall continue to pay for transmission services provided up to the time of disconnection of its facilities.
- 20.5.4. The Customer shall pay all reasonable costs, including the costs of removing any of the Transmitter's equipment from the Customer's facilities, that are directly attributable to the disconnection and, where applicable, the subsequent decommissioning of the Customer's facilities. The Transmitter shall not require the removal of the protection and control wiring within the Customer's facilities.
- 20.5.5. While the Customer's facilities are disconnected, the Transmitter shall not be required to convey electricity to or from the Customer's facilities.

## **PART SEVEN**

### **EXCHANGE AND CONFIDENTIALITY OF INFORMATION**

#### **21. EXCHANGE AND CONFIDENTIALITY OF INFORMATION**

21.1. For purposes of this Agreement, "Confidential Information" does not include:

- (a) information that is in the public domain, provided that specific items of information shall not be considered to be in the public domain merely because more general information is in the public domain and provided that the information is not in the public domain as a result of a breach of confidence by the Party seeking to disclose the information or a person to whom it has disclosed the information; or
- (b) information that is, at the time of the disclosure, in the possession of the receiving Party, provided that it was lawfully obtained from a person under no obligation of confidence in relation to the information.

21.2 Subject to section 21.3, each Party shall treat all Confidential Information disclosed to it by the other Party as confidential and shall not, without the written consent of that other Party:

- (a) disclose that Confidential Information to any other person; or
- (b) use that Confidential Information for any purpose other than the purpose for which it was disclosed or another applicable purpose contemplated in this Agreement.

Where a Party, with the written consent of the other Party, discloses Confidential Information of that other Party to another person, the Party shall take such steps as may be required to ensure that the other person complies with the confidentiality provisions of this Agreement.

21.3. Nothing in section 21.2 shall prevent the disclosure of Confidential Information:

- (a) where required under this Agreement, the Market Rules or a licence;
- (b) where required by law or regulatory requirements;
- (c) where required by order of a government, government agency, regulatory body or regulatory agency having jurisdiction;

- (d) if required in connection with legal proceedings, arbitration or any expert determination relating to the subject matter of this Agreement, or for the purpose of advising a Party in relation thereto;
  - (e) as may be required to enable the Transmitter to fulfill its obligations to any reliability organization;
  - (f) as may be required during an emergency or to prevent or minimize the effects of an emergency; or
  - (g) by the Customer to a Lender or prospective Lender.
- 21.4. Notwithstanding any provision of section 15, a Party that breaches section 21.2 shall be liable to the other Party for any and all Party Losses of that other Party arising out of such breach.
- 21.5. The Parties acknowledge and agree that the exchange of information, including Confidential Information, under this Agreement is necessary for maintaining the reliable operation of the Transmitter's transmission system. The Parties further agree that all information, including Confidential Information, exchanged between them shall be prepared, given and used in good faith and shall be provided in a timely and cooperative manner.
- 21.6. Each Party shall comply with its information exchange obligations as set out in this Agreement, including in Schedule I. In addition, each Party shall provide the other with such information as the other may reasonably require to enable it to perform its obligations under this Agreement.
- 21.7. Each Party shall as soon as practicable notify the other Party upon becoming aware of a material change or error in any information previously disclosed to the other Party under this Agreement and, in the case of the Customer, in any information contained in its application for connection. The Party shall provide updated or corrected information as required to ensure that information provided to the other Party is up to date and correct.

**PART EIGHT**  
**TRANSMISSION SERVICE AND OTHER CHARGES**

**22. TRANSMISSION SERVICE AND TRANSMISSION SERVICE CHARGES**

- 22.1. The Transmitter shall provide transmission services to the Customer in accordance with this Agreement and the Transmitter's Rate Order.
- 22.2. The Parties shall comply with their respective obligations as set out in Schedule B in relation to transmission service.
- 22.3. The Transmitter shall not charge the Customer for transmission services except in accordance with the Transmitter's Rate Order.
- 22.4. The Customer shall pay for charges for transmission services in accordance with Schedule B.

**23. OTHER CHARGES AND PAYMENTS**

- 23.1. In addition to charges for transmission service, the Transmitter may require that the Customer pay the following:
  - (a) a capital contribution in relation to the construction of new or modified transmission facilities, where permitted by and determined in accordance with the Code;
  - (b) fees or charges approved by the Board, including fees or charges approved as part of the transmitter's Board-approved connection procedures referred to in section 6.1.4 of the Code; and
  - (c) any other fees, charges or costs expressly provided for in this Agreement.



**PART NINE**  
**TECHNICAL AND OPERATING REQUIREMENTS**

**24. FACILITY STANDARDS**

24.1. The Transmitter shall comply with section 4.3.1 of the Code. The Customer shall ensure that its facilities:

- (a) meet all applicable requirements of the Ontario Electrical Safety Authority, subject to any exemption that may have been granted to or that may apply to the Customer;
- (b) conform to all applicable industry standards, including those of the Canadian Standards Association, the Institute of Electrical and Electronic Engineers, the American National Standards Institute, and the International Electrotechnical Commission (IEC);
- (c) are constructed, operated and maintained in accordance with this Agreement, the Customer's licence, the Market Rules, all applicable reliability standards and good utility practice;
- (d) where they are connection facilities, are made by it with due regard for the safety of the Customer's employees and the public;
- (e) where they are connection facilities, are made by it on a timely basis and are designed and constructed by it in accordance with the applicable provisions of the Transmitter's Board-approved connection procedures or, in the absence of such Board-approved connection procedures, in accordance with section 6.1.8 of the Code; and
- (f) where they are connection facilities, do not materially reduce the reliability or performance of the Transmitter's transmission system and are constructed with such mitigation measures as may be required so that no new available fault current level exceeds the maximum allowable fault levels set out in Appendix 2 of the Code if this would have an adverse effect on the Transmitter. Where the new available fault current level would exceed the maximum allowable fault level set out in Appendix 2 of the Code and would have an adverse effect on the Transmitter the Customer may, as an alternative, make suitable arrangements with the Transmitter to mitigate the economic or financial impact of allowing the new available fault current level to exceed the maximum allowable fault level set out in Appendix 2 of the Code. Such arrangements shall be consistent with the cost responsibility principles set out in the Code.

24.2. The Customer shall ensure that those of its facilities that are connected to the Transmitter's transmission system, other than the facilities identified in section H.1 of

Schedule H, comply with the basic general performance standards and technical requirements set out in the Code, including in Appendix 2.

- 24.3. Where the Transmitter, after conducting a Customer Impact Assessment under section 6.4 of the Code, provides the Customer with a new available fault current level, the Customer shall, at its own expense, upgrade its facilities as may be required to accommodate the new available fault current level. This obligation shall not apply to the extent that the new available fault current level exceeds the maximum allowable fault levels set out in Appendix 2 of the Code except where suitable financial arrangements have been made with the Customer as contemplated in the last paragraph of section 6.1.2 of the Code.

- 24.4. The Transmitter and the Customer shall fully cooperate to ensure that modelling data required by this Agreement for the planning, design and operation of connections are complete and accurate. The Transmitter shall conduct, or may require that the Customer conduct, such tests as may be required where the Transmitter believes on reasonable grounds that the accuracy of such data is in question. The Party conducting such tests shall promptly report the results to the other Party. Where the tests are conducted by the Transmitter, the tests shall be conducted at a time that is mutually agreed by the Customer and the Transmitter, and the Customer shall reimburse the Transmitter for the costs and expenses reasonably incurred by the Transmitter in conducting the tests. If the testing is required to be rescheduled at the request of a Party or by reason of a Party's failure to attend, that Party shall, at the request of the other Party, pay all reasonable costs incurred by the other Party in respect of the rescheduling of the test.
- 24.5. The Customer shall, at the Transmitter's request, permit the Transmitter to participate in the commissioning, inspection, and testing of the Customer's facilities so as to enable the Transmitter to ensure that the Customer's facilities will not adversely affect the reliability of the Transmitter's transmission system.
- 24.6. Where section 24.5 applies, the commissioning, inspection or testing of the Customer's facilities shall be conducted at a time that is mutually agreed by the Customer and the Transmitter. If the commissioning, inspection or testing is required to be rescheduled at the request of a Party or by reason of a Party's failure to attend, that Party shall, at the request of the other Party, pay all reasonable costs incurred by the other Party in respect of the rescheduling of the commissioning, inspection or testing activity.

## **25. ADDITIONAL TECHNICAL REQUIREMENTS**

- 25.1. Each Party shall comply with their respective obligations as set out in Schedules E, F and G.
- 25.2. Each Party shall ensure that its facilities meet the technical requirements set out in Schedules E, F and G.

## **26. OPERATIONAL STANDARDS AND REPORTING**

- 26.1. As of the date of this Agreement, the fault levels at all connection points applicable to the Customer's facilities and the assumptions underlying those fault levels, as specified by the Transmitter in accordance with the Market Rules, are set out in section D.1 of Schedule D. The Transmitter shall update such fault levels as may be required under this Agreement or in response to a request by the Customer under section 26.2, and the Parties shall amend Schedule D accordingly.
- 26.2. The Customer acknowledges that the fault levels at connection points applicable to the Customer's facilities will change from time to time, and agrees that it may not rely upon the fault levels as specified section D.1. of Schedule D. Where the Customer reasonably requires confirmation of the fault levels at a connection point applicable to the

Customer's facilities, the Customer shall submit a request to that effect to the Transmitter. The Transmitter shall then provide the Customer with the current fault levels.

- 26.3. The Customer shall promptly report to the Transmitter any changes in its facilities that could materially affect the performance of the Transmitter's transmission system.
- 26.4. The Customer shall, at the Transmitter's request, promptly report to the Transmitter any and all incidents involving the automatic operation of the Customer's facilities' protective relays that affect the Transmitter's transmission facilities.
- 26.5. The Transmitter shall promptly report to the Customer any changes in its facilities that could materially affect any transmission services provided to the Customer under this Agreement.

## **27. OPERATIONS AND MAINTENANCE**

### **27.1. Work on Site of Other Party**

- 27.1.1. When a Party is conducting work at the other Party's site, the working Party shall:
  - (a) subject to section 27.1.2, comply with all of the host Party's practices and requirements relating to occupational health and safety and environmental protection;
  - (b) comply with all applicable law relating to occupational health and safety and environmental protection; and
  - (c) comply with all of the host Party's reasonable practices and requirements relating to security of the host Party's site, including entering into an access agreement on reasonable terms relating to security of the host Party's site.
- 27.1.2. When a Party is conducting work at the other Party's site, the working Party shall comply with its own practices and requirements in relation to occupational health and safety and environmental protection:
  - (a) to the extent permitted by the host Party, which permission shall not be granted unless the host Party is satisfied that the working Party's practices and requirements provide for a level of safety or protection that equals or exceeds its own; or
  - (b) to the extent that the host Party has not made its practices or requirements known to the working Party.

## **27.2. General**

27.2.1. Each Party shall ensure that its facilities are operated and maintained only by persons qualified to do so.

27.2.2. Each Party shall operate and maintain its facilities in accordance with Schedule A.

## **27.3. Controlling Authorities**

27.3.1. The Controlling Authority for each Party is the person identified as such in Schedule A. A Party may, by written notice to the Controlling Authority of the other Party, from time to time change its Controlling Authority, and the Parties shall amend Schedule A accordingly.

27.3.2. A Party shall comply with any request received from the Controlling Authority of the other Party.

## **27.4. Communication Between the Parties**

27.4.1. Except as otherwise provided in this Agreement, all communications between the Parties relating to routine operating and maintenance matters shall be exchanged between the Parties' respective Controlling Authorities in accordance with the contact information set out in Schedule A, or as otherwise specified in Schedule A.

27.4.2. Each Party shall provide the other Party with a communications protocol to be used by that other Party in emergency situations. The protocol shall include the name of the Party's site emergency coordinator.

## **27.5. Switching**

27.5.1 Each Party shall, through its Controlling Authority, develop a written protocol that establishes the conditions for, and the coordination of, switching in respect of equipment under its control.

27.5.2. The Parties shall, through their respective Controlling Authorities, approve one another's switching protocols.

27.5.3. A Party may, with the consent of the other Party, appoint an employee of the other Party as its designate for switching purposes, provided that orders to operate must be issued by the Party's Controlling Authority.

27.5.4. The Transmitter may issue to the Customer, and the Customer shall comply with, such switching instructions as may be required to maintain the security and reliability of the Transmitter's transmission system.

27.5.5. The Controlling Authorities of the Parties shall, prior to the time at which any switching activity is to occur, agree upon procedures for such switching activity.

## **27.6 Isolation of Facilities at Customer's Request**

27.6.1. A Party shall not, other than in an emergency, operate an isolating disconnect switch except on prior notice to the other Party.

27.6.2. If the Customer requires isolation of its own facilities or of facilities under the Transmitter's control, the Customer's Controlling Authority shall deliver a written notice to that effect to the Transmitter's Controlling Authority. The written notice shall contain the following:

- (a) a request that the Transmitter's Controlling Authority provide a Supporting Guarantee;
- (b) the Transmitter's assigned equipment operating designations, if applicable; and
- (c) the Customer's assigned equipment operating designations, if the Transmitter's equipment operating designations have not been assigned.

27.6.3. After the written notice referred to in section 27.6.2 has been delivered, the Customer's Controlling Authority may request, and the Transmitter's Controlling Authority shall ensure, that the isolation and subsequent reconnection of the Customer's relevant equipment is done on a timely basis. The Parties shall bear their own costs and expenses associated with such isolation and reconnection.

27.6.4. The Transmitter may, provided that it has given advance notice to the Customer, lock the isolating disconnect switch in the open position in any of the following circumstances:

- (a) where necessary to protect the Transmitter's personnel or equipment and the Transmitter has received a Supporting Guarantee from the Customer, in which case the lock shall be under the Transmitter's control for the duration of the Supporting Guarantee;
- (b) where the operation of the Transmitter's equipment interferes with the operation of the Customer's equipment;
- (c) where equipment owned by either Party interferes with the operation of the Transmitter's transmission system; or
- (d) where the Transmitter has been directed by the IESO to do so in accordance with the Market Rules.

## **27.7. Isolation of Facilities at Transmitter's Request**

27.7.1. If the Transmitter requires isolation of its own facilities from the Customer's facilities or isolation of facilities under the Customer's control, the Transmitter's Controlling Authority shall deliver a written notice to that effect to the Customer's Controlling Authority. The written notice shall contain a request that the Customer's Controlling Authority provide a Supporting Guarantee that identifies the Customer's assigned equipment operating designations.

27.7.2. After the written notice referred to in section 27.7.1 has been delivered, the Transmitter's Controlling Authority may request, and the Customer's Controlling Authority shall ensure, that the isolation and subsequent reconnection of the Transmitter's relevant equipment is done on a timely basis. The Parties shall bear their own costs and expenses associated with such isolation and reconnection.

## **27.8. Alternative Method of Isolation**

27.8.1. A Party may establish its own Work Protection in place of obtaining a Supporting Guarantee from the other Party.

27.8.2. The Party whose facilities are required in order to establish Work Protection shall provide the other Party with access to those facilities.

27.8.3. Establishing Work Protection shall be limited to the hanging of tags and the locking of devices.

## **27.9. Forced Outages**

27.9.1. Where the forced outage of the facilities of one Party adversely affects the facilities of the other Party, the Controlling Authority of the Party experiencing the forced outage shall promptly notify the Controlling Authority of the other Party of the forced outage.

27.9.2. The Controlling Authority of a Party shall have sole authority to identify the need for and to initiate a forced outage of that Party's facilities.

## **27.10. Planned Work**

27.10.1. Where planned work to be performed by a Party may affect the safety of the other Party's personnel, the Party performing the work shall provide the other Party with all required Work Protection documentation and related notices in writing or by such other means as they may agree in writing.

27.10.2. Where planned work on the facilities of a Party:

- (a) requires the participation or cooperation of the other Party; or
- (b) could adversely affect the normal operation of the other Party's facilities,

the other Party shall use commercially reasonable efforts to accommodate the planned work and shall negotiate in good faith the reasonable procedures and cost sharing criteria applicable to the planned work.

- 27.10.3. The Customer shall take all reasonable steps to ensure that all anticipated and planned outages of its facilities for each calendar year are submitted to the Transmitter by October 1<sup>st</sup> of the preceding year.
- 27.10.4. All planned work on the Customer's facilities that may affect the Transmitter's transmission facilities shall be scheduled by the Customer with the Transmitter's Controlling Authority.
- 27.10.5. Where the Customer plans work on its facilities that:
- (a) requires a feeder breaker to be opened or operated;
  - (b) requires any disconnection or isolation from any facilities of either Party that are less than 50 kV, such as a feeder breaker;
  - (c) will result in power flow changes of greater than 5 MW; or
  - (d) will involve a transfer or switching operation that directly affects the Transmitter's transmission facilities,

the Customer's Controlling Authority shall submit a request to the Transmitter's representative identified in Schedule A, including a request to provide a Supporting Guarantee where applicable. Such request shall be submitted in writing and shall be submitted at least four days in advance of the planned work or within such other period as the Parties may agree.

- 27.10.6. Where the Customer plans work on its facilities that requires that multiple feeder breakers, a station bus or a whole transformer station be operated, the Customer's Controlling Authority shall submit a request to the Transmitter's representative identified in Schedule A, including a request to provide a Supporting Guarantee where applicable. Such request shall be submitted in writing and shall be submitted at least ten days in advance of the planned work or within such other period as the Parties may agree.
- 27.10.7. Where the Transmitter plans work on its facilities that directly affects the Customer's facilities and that requires that multiple feeder breakers, a station bus or a whole transformer station be operated, the Transmitter's Controlling Authority shall give notice of the planned work to the Customer's representative identified in Schedule A. Such notice shall be submitted in writing and shall be submitted at least ten days in advance of the planned work or within such other period as the Parties may agree.



- 27.10.8. Where the Transmitter plans work on its facilities that directly affects the Customer's facilities and that requires a feeder breaker to be opened or operated, the Transmitter's Controlling Authority shall give notice of the planned work to the Customer's representative identified in Schedule A. Such notice shall be submitted in writing and shall be submitted at least four days in advance of the planned work or within such other period as the Parties may agree.
- 27.10.9. The Controlling Authority of a Party may submit to the other Party a written request for permission to re-schedule planned work that has been previously notified to or scheduled with that other Party. Such request must be given in writing at least two business days prior to the date on which the planned work was originally scheduled to occur.
- 27.10.10. If a Party's request to re-schedule cannot be reasonably accommodated by the other Party and the Parties cannot agree on an alternate date, the matter shall be submitted to the dispute resolution process set out in section 17.

## **27.11. Shutdown of Customer's Facilities**

- 27.11.1. The Customer's Controlling Authority shall promptly notify the Transmitter's Controlling Authority in the event that the Customer's facilities are shut down for any reason. The Transmitter shall investigate and determine the cause of the shutdown, using available evidence including input from the Customer's staff.
- 27.11.2. Once the Transmitter is satisfied that reconnection of the Customer's facilities following a shut down will not adversely affect the Transmitter's transmission system, the Transmitter shall notify the Customer as soon as practicable that it may reconnect its facilities to the Transmitter's transmission facilities. The Customer shall not reconnect its facilities to the Transmitter's transmission facilities following a shut down until authorized to do so by the Transmitter's Controlling Authority. Reconnection shall be effected in accordance with the Transmitter's Board-approved reconnection procedures referred to in section 6.10.3 of the Code or, in the absence of such procedures, in accordance with procedures agreed between the Parties.

## **27.12. Emergency Operations**

- 27.12.1. During an emergency or in order to prevent or minimize the effects of an emergency, a Party may without prior notice to the other Party take whatever immediate action it deems necessary to ensure public safety or to safeguard life, property or the environment.
- 27.12.2. Where a Party takes action under section 27.12.1, it shall promptly report the action taken and the reason for that action to the other Party's Controlling Authority.

27.12.3. In an emergency, the Parties shall communicate in accordance with the communications protocols provided to one another under section 27.4.2.

**27.13. Access to and Security of Facilities**

27.13.1. Each Party shall ensure that its facilities are secure at all times. Where a Party's facilities are located on the site of another Party, the Parties shall cooperate to ensure the security of those facilities in accordance with section 27.1.1(c).

27.13.2. Each Party shall be entitled to access the site or facilities of the other Party at all reasonable times where required in order to carry out work on its facilities or where otherwise permitted or required under this Agreement. Such access shall be effected in accordance with sections 27.13.4 and 27.13.5.

27.13.3. Each Party shall, to facilitate the exercise by the other Party of its access rights, provide that other Party with all applicable access procedures, including procedures relating to access codes and keys.

27.13.4. Where a Party wishes to exercise its right of access to the site or facilities of the other Party, the accessing Party shall provide reasonable prior notice to the host Party of the date, time and location of access and of the nature of the work to be undertaken. Where the accessing Party's access cannot reasonably be accommodated by the host Party, the Parties shall agree on another date and time for access.

27.13.5. Where a Party is exercising its right of access, the Party shall:

- (a) comply with the obligations set out in section 27.1;
- (b) ensure that any person that will have access to the host Party's site or facilities has been properly trained;
- (c) comply with the procedures provided to it by the host Party under section 27.13.3;
- (d) not damage or interfere with the host Party's property (provided that the exercise of the right of access shall not itself be considered interference); and
- (e) not interact with representatives of the host Party other than the person designated for such purpose by the host Party or as may be permitted by that designated person.

27.13.6. Where an accessing Party causes damage to or loss of any property of the host Party, the accessing Party shall promptly notify the host Party. Notwithstanding

any provision of section 15, the accessing Party shall pay to the host Party the host Party's reasonable costs of repairing such property or, if such property cannot be repaired, of replacing such property.

27.13.7. Where the property of a Party is on the site of the other Party, the host Party shall not interfere with or cause damage to or the loss of that property. Where the host Party causes such damage or loss, the host Party shall promptly notify the other Party. Notwithstanding any provision of section 15, the host Party shall pay to the other Party the other Party's reasonable costs of repairing such property or, if such property cannot be repaired, of replacing such property.

27.13.8. In addition to the general right of access referred to in section 27.13.2, the Transmitter may access the site or facilities of the Customer in order to ensure that the Customer's facilities comply with the requirements of this Agreement or for the purpose of investigating a threat or potential threat to the security of the Transmitter's transmission system. Such right of access shall be exercised in accordance with the provisions of this section 27.13.

27.13.9. Nothing in this section 27.13 shall prevent or restrict a Party from doing any of the following in an emergency or where required to prevent or minimize the effects of an emergency:

- (a) interfering with the property of the other Party that is on its site; or
- (b) accessing the site of the other Party without notice.

Where a Party takes such action and causes damage to or loss of the property of the other Party, the acting Party shall promptly notify the other Party. Notwithstanding any provision of section 15, the acting Party shall pay to the other Party the other Party's reasonable costs of repairing such property or, if such property cannot be repaired, of replacing such property.

## **28. INSPECTION, TESTING, MONITORING AND NEW, MODIFIED OR REPLACEMENT CUSTOMER FACILITIES**

### **28.1. General Requirements**

28.1.1. The Customer shall inspect, test and monitor its facilities to ensure continued compliance with all applicable instruments and standards referred to in paragraphs (a) to (c) of section 24.1.

28.1.2. Where the Transmitter carries out any inspection, testing or monitoring of the Customer's facilities where required or permitted under this Agreement, the Customer shall pay the Transmitter's reasonable costs of doing so.

- 28.1.3. The Transmitter shall inspect, test and monitor its transmission facilities to ensure continued compliance with all applicable instruments and standards referred to in section 4.3.1 of the Code.
- 28.1.4. Each Party shall maintain complete and accurate records of the results of all performance inspection, testing and monitoring that it conducts in fulfillment of its obligations under this Agreement. Such records shall be maintained by each Party for a minimum of seven years or for such shorter time as the Board may permit.
- 28.1.5. Each Party shall, at the request of the other, provide the other Party with the records referred to in section 28.1.4. Without limiting the generality of the foregoing, the Customer shall, at the Transmitter's request, provide the Transmitter with:
- (a) test certificates certifying that the Customer's facilities have passed all relevant tests and comply with all applicable instruments and standards referred to in paragraphs (a) to (c) of section 24.1; and
  - (b) copies of any certificates of inspection or other applicable authorizations or approvals received from the Ontario Electricity Safety Authority in relation to the Customer's facilities.

## **28.2. New, Modified or Replacement Customer Facilities**

- 28.2.1. The Customer shall, at the Transmitter's request, permit the Transmitter to inspect, test or witness the commissioning of any of the Customer's new, modified or replacement facilities where the Transmitter reasonably considers that such new, modified or replacement facilities may adversely affect the performance of the Transmitter's transmission system. The Customer shall pay the Transmitter's reasonable costs of doing so.
- 28.2.2. Where section 28.2.1 applies, the inspection, testing or commissioning of the Customer's facilities shall be conducted at a time that is mutually agreed by the Customer and the Transmitter. If the inspection, test or commissioning is required to be rescheduled at the request of a Party or by reason of a Party's failure to attend, the Party shall, at the request of the other party, pay all reasonable costs incurred by the other Party in respect of the rescheduling of the inspection, testing or commissioning activity.
- 28.2.3. The Customer shall, at the Transmitter's request, provide the Transmitter with test certificates, including any certificates of inspection or other applicable authorizations or approvals that the Ontario Electrical Safety Authority may have issued, certifying that any of the Customer's new, modified or replacement facilities have passed the relevant tests and comply with all applicable instruments and standards referred to in paragraphs (a) to (c) of section 24.1. The

Transmitter may require the provision of these certificates as a condition of connecting any of the Customer's new, modified or replacement facilities. The Customer acknowledges that the Transmitter cannot, where a connection authorization or other applicable authorization or approval issued by the Ontario Electrical Safety Authority is required in relation to the Customer's new, modified or replacement facilities, connect such facilities unless that connection authorization has been issued.

- 28.2.4. The Transmitter shall provide to the Customer such technical parameters as may be required to assist the Customer in ensuring that the design of the Customer's facilities shall be consistent with the requirements applicable to the Transmitter's transmission system as set out in this Agreement.
- 28.2.5. The Customer shall not make any modifications to its facilities of a type that is specified in section D.2 of Schedule D without the prior approval of the Transmitter.
- 28.2.6. Where the Transmitter considers that a type of modification that is not already specified in section D.2 of Schedule D is likely to have a material adverse effect on the Transmitter's transmission facilities, on the facilities of another of the Transmitter's customers or on the facilities of one of the Transmitter's neighbouring Ontario transmitters, the Transmitter shall so notify the Customer. The Parties shall then negotiate in good faith appropriate amendments to section D.2 of Schedule D.

**PART TEN**  
**SCHEDULE K**

**29. COMPLIANCE WITH SCHEDULE K**

29.1. The Parties shall comply with their respective obligations under Schedule K.

**IN WITNESS WHEREOF**, the Parties hereto, intending to be legally bound, have caused this Agreement to be executed by their duly authorized representatives.

Name of Transmitter

Name of Customer

By: Name: \_\_\_\_\_

By: Name: \_\_\_\_\_

**SCHEDULE A**

**SINGLE LINE DIAGRAM, DESCRIPTION OF THE CUSTOMER'S CONNECTION POINT(S) AND DETAILS OF SPECIFIC OPERATIONS**

**A.1. SINGLE LINE DIAGRAM AND CONNECTION POINT(S)**

[to be inserted by the Parties]

**A.2. LIST OF FACILITIES ON THE PROPERTY OF THE OTHER PARTY**

A.2.1. The following Customer facilities are located on the Transmitter's site:

[to be completed by the Parties]

A.2.2. The following Transmitter's transmission facilities are located on the Customer's site:

[to be completed by the Parties]

**A.3. TELEPHONE CONTACT**

A.3.1. Either Party has the right to change the position designations and telephone numbers listed below with immediate effect at any time by notice in writing delivered to the other Party by fax or other telegraphic means. Any employee of a Party with apparent authority may deliver such a notice to the other Party.

**A.4. OWNER AND OPERATING CONTROL**

A.4.1. A Party may change its designated controlling authority set out below at any time during the term of the Agreement, subject to the following conditions:

- (a) the Transmitter may change its designated controlling authority only for the Transmitter's transmission facilities;

**Day to Day Operations**

For the operation of the Transmitter's transmission facilities and the Customer's facilities.

	<b>Transmitter</b>	<b>Customer</b>
<b><u>Operating Contacts:</u></b>		
Position:		
Name:		
Location:		
Phone Number:		
Fax Number:		

---

**Outage Planning:**

Position:  
Name:  
Location:  
Phone Number:  
Fax Number:

---

Position:  
Name:  
Location:  
Phone Number:  
Fax Number:

---

Position:  
Name:  
Location:  
Phone Number:  
Fax Number:

---

**Notes:****Contract Administration for operating services**

---

**Transmitter****Customer**

---

Position:  
Name:  
Location:  
Phone Number:  
Fax Number:

---

Position:  
Name:  
Location:  
Phone Number:  
Fax Number:

---

Position:  
Name:  
Location:  
Phone Number:  
Fax Number:

---

**A.4. OWNER AND OPERATING CONTROL**



A.4.1. A Party may change its designated controlling authority set out below at any time during the term of the Agreement, subject to the following conditions:

- (a) the Transmitter may change its designated controlling authority only for the Transmitter’s transmission facilities;
- (b) the Customer may change its designated controlling authority only for the Customer;
- (c) either Party shall notify the other in writing of any change in its designated controlling authority at least ten business days before implementing a change; and
- (d) notification of any changes to the controlling authority shall be exchanged between the Transmitter and the Customer as follows:

<b>Transmitter</b>	<b>The Customer</b>
Director – Transmission Operations Division	General Manager [Appropriate level of Management to be identified by the Customer]
All affected Controlling Authorities and Transmission Operations Management Centre	All affected Controlling Authorities

A.4.2. The Customer:

- (a) owns:
- (b) has operating control of:

A.4.3. The Transmitter:

- (a) owns:
- (b) has operating control of:

**A.5. Metering Facilities Diagram**

This diagram is based on the protection, control, and metering diagram.

**A.6. Normal Operations**

This Schedule shall include Customer-specific Information during normal operations.

**A.7. Emergency Operations**

This Schedule would include Customer specific Information during Emergency operations.

**A.8. Re-verification Schedules-Protection and Control (sample only)**

A.8.1. A Customer shall re-verify its station protections and control systems that can impact on the Transmitter's transmission system. The verifications will generally be carried out during generation outages. Where this cannot be accommodated within the time periods required for NPCC reporting, an entry will be made in the "EXCEPTIONS TO THE MAINTENANCE CRITERIA FOR BULK SYSTEM PROTECTION". The target date for the completion of the program will be indicated.

A.8.2. Customer shall advise the Transmitter at least fourteen (14) business days' notice of its intention to conduct a re-verification test, so that the Transmitter's protection and control staff and system performance staff (if required) can observe:

- (a) re-verification of protection equipment settings specified in this Agreement;
- (b) relay recalibration;
- (c) test tripping of station breakers that impact on the Transmitter/Customer interface measurement and analysis of secondary AC voltages and currents to confirm measuring circuit integrity as well as protection directioning; and
- (d) measurement and analysis of secondary AC voltages and currents to confirm measuring circuit integrity.

**Note:** All tests must be coordinated and approved ahead of time through the normal outage planning process.

A.8.3. The following specific actions are required:

- (a) observe all station protections that trip and open the “enter the devices that interface with the Transmitter” for proper operation; and
- (b) confirm that settings approved by the Transmitter are applied to the following protections:
  - (i) over and under voltage;
  - (ii) transformer differential;
  - (iii) transformer phase and ground backup protection;
  - (iv) line protections;
  - (v) breaker or HVI failure protection; and
  - (vi) transfer and remote trip protections.

#### **A.9. General Protections (sample only)**

1. There are no line protections at Site.
2. Transformer faults are cleared by the high voltage (HV) and medium voltage (MV) breakers.
3. The transformer protection sends a block to the Transmitter’s network transformer station or switching station to prevent out of zone tripping.
4. Breaker failure protection sends transfer trip and it is then cascaded to other stations.
5. Under Frequency Load Shedding relays that operate as follows:

[Set out Particulars]

#### **A.10. Telecommunication Facility Details for Protection and Control Applications (sample only)**

##### **A.10.1. Telecommunication Medium**

The communication medium used will be two (2) leased telephone circuits from Bell Telephone and these circuits are the responsibility of the Customer

##### **A.10.2. Types of Telecommunication Channels**

- 2 Blocking Channels
- 2 Transfer Trip Channels

##### **A.10.3. Ownership of Telecommunication Terminal Equipment**

The terminal equipment located at a given facility is owned by the Customer. The communication medium (leased telephone circuits) is considered to be owned by the Customer. Therefore, the Customer is responsible for the restoration of the failed communication medium.

The terminal equipment located at a switching station is owned by the Transmitter.

#### **A.10.4. Responsibility for Work and Costs Associated with Breakdown and Routine Maintenance**

If maintenance is required on the terminal equipment located at the Customer's facility, the Customer will bear all incurred costs.

If maintenance is required on terminal equipment located at sites owned by the Transmitter, the Transmitter will bear all incurred costs.

If maintenance or repair is required on the leased telephone circuits, the Customer will incur all associated costs. These costs will include charges by Bell Telephone and the Transmitter if its personnel are required to participate in any of the related activities.

#### **A.10.5. Reverification Schedule**

Routine Maintenance on communication equipment and the communication channels must be performed every two years.

#### **A.10.6. Inventory of Communication Equipment**

The provision of spare communication equipment is the Customers' responsibility and will be located at its site.

#### **A.10.7. Failure of Communication Equipment**

If a communication failure affects either the transfer trip channels or the blocking channels; the Transmitter will decide whether or not the Customer should remain connected to the high-voltage system. The Transmitter must advise the Customer, through the appropriate communication protocol outlined in this code, of the situation, the choices available to the Customer and the risks involved. Since the Transmitter will take the decision according to its own interests, the Customer can choose to remain or separate from the high-voltage system at its own risk.

#### **A.10.8. Mean Time for Repairs**

The mean time for repairs will be within two working days, dependent on the availability of staff of Bell Telephone and the Transmitter.

#### **A.10.9. Provision of Purchase Order by Customer to Transmitter**

The Customer will provide the Transmitter's designated leader with a purchase order, so that the Transmitter may apply appropriate charges to the Customer.

## **SCHEDULE B**

### **TRANSMISSION SERVICES AND ASSOCIATED CHARGES**

- B.1. This Schedule applies where the Customer's facilities are connected to those of the Transmitter's transmission facilities that form part of the IESO-controlled grid.
- B.2. In this Schedule and in Attachment B1:
- (a) the terms "Delivery Point" and "Network Service" shall have the meaning given to them in the Transmitter's Rate Order; and
  - (b) the terms "Registered Wholesale Meter", "Metering Registry" and "Metering Service Provider" shall have the meaning given to them in the Market Rules.
- B.3. The Customer shall not be entitled to receive, and the Transmitter shall not be required to provide, any transmission services unless the Customer and the Customer's facilities comply with all applicable requirements of this Agreement and with all revenue metering and associated billing and settlement requirements of the Market Rules.
- B.4. Where the Customer wishes to obtain Export Transmission Service, the Customer shall arrange for and obtain that transmission service in accordance with the requirements of the Market Rules.
- B.5. Charges for transmission services provided to the Customer shall be determined and billed in accordance with the Transmitter's Rate Order and the Market Rules.
- B.6. Transmission service charges shall be paid by the Customer to the IESO in accordance with the Market Rules. A dispute related to an amount payable by the Customer to the IESO on account of transmission service charges that is subject to the dispute resolution provisions of the Market Rules shall be resolved in accordance with those provisions. Nothing in this section B.6 shall preclude a Customer from initiating a dispute under this Agreement in relation to the applicability of transmission service charges or the classification of transmission service charges.
- B.7. The Parties may agree to use Attachment B1 or an amended version of Attachment B1 in connection with the payment of transmission service charges.

## Attachment B1

### **Billing for Transmission Service Charges and Designation of Agent (as permitted by section B.7 of Schedule B)**

As contemplated in the Transmitter's Rate Order, the IESO will submit invoices for transmission services to market participants that utilize Network Service or Export Transmission Service.

The Market Rules and the Transmitter's Rate Order require that transmission service charges payable by transmission customers shall be collected by the IESO. The billing and settlement processes used by the IESO are designed to collect transmission service charges from entities that are market participants, using meter readings that are totalized and loss adjusted. The Customer shall ensure that any Registered Wholesale Meter used for the purposes of determining transmission service charges payable by the Customer satisfy the wholesale metering requirements and associated obligations specified in Chapter 6 of the Market Rules (including the appendices to that Chapter).

The Customer may wish to designate to another entity that is a market participant (referred to as the "Transmission Customer Agent") the responsibility for paying some or all of the transmission service charges payable by the Customer and the responsibility for satisfying the wholesale metering requirements and associated obligations specified in Chapter 6 of the Market Rules (including the appendices to that Chapter). Any such designation shall be made on the basis of delivery points and associated connection points with respect to which the Customer has transferred the obligations to the Transmission Customer Agent.

Where the Customer wishes to so designate another entity as its Transmission Customer Agent, the Customer and the Transmission Customer Agent shall sign the form set out below and return it to the Transmitter. Once the designation takes effect, the transmission service charges payable by the Transmission Customer Agent will be calculated by the IESO as though the Transmission Customer Agent were the Customer with respect to the designated connection points at the applicable delivery points. Except as otherwise provided in Schedule B, the demand designated to the Transmission Customer Agent by the Customer shall not be aggregated with any demand for which (a) the Customer retains the obligation to pay transmission service charges, (b) the Customer designates the obligation to another entity, or (c) another customer of the Transmitter designates the obligation to the Transmission Customer Agent.

-----

#### Transmission Customer Designation Form

The undersigned Customer hereby transfers to the undersigned Transmission Customer Agent, and the undersigned Transmission Customer Agent hereby assumes and agrees to honour, all obligations and responsibilities for each Registered Wholesale Meter and the payment of transmission service charges associated with the connection points listed below. This transfer of

obligations and responsibilities is in accordance with Schedule B of the Connection Agreement between the Customer and the Transmitter. The undersigned Transmission Customer Agent hereby agrees to register as a market participant with the IESO and to be subject to all of the requirements of the Market Rules for the purposes of payment of transmission service charges associated with the delivery points and associated connection points listed below. The Customer and the Transmission Customer Agent, as applicable, undertake to notify and oblige their respective Metering Service Provider(s) to ensure that the Metering Registry data maintained by the IESO in accordance with Chapter 6 of the Market Rules (including the appendices to that Chapter) is updated consistent with this designation.

List of delivery points and associated connection points for which obligations and responsibilities are transferred:

Delivery point	Description of associated connection points

<u>On Behalf of Customer</u>	<u>On Behalf of Transmission Customer Agent</u>
Signed: _____	Signed: _____
Title: _____	Title: _____
Date: _____	Date: _____
Business Name and Address: _____ _____ _____ _____	Business Name and Address: _____ _____ _____ _____

Received by Transmitter

Business Name: \_\_\_\_\_



Signed: \_\_\_\_\_

Title: \_\_\_\_\_

Date: \_\_\_\_\_

The designation contained herein shall become effective once the Metering Service Provider(s) for the Customer and the Transmission Customer Agent submit(s) the information required in accordance with the change management process for the Metering Registry maintained by the IESO.

## SCHEDULE C

### CURE PERIODS FOR DEFAULTS

C.1. The Cure Period for a Financial Default shall be:

- (a) seven business days; or
- (b) ten business days, where notice has been given to the Transmitter under section 19.4.1.

C.2. The Cure Period for a Non-financial Default shall depend on the impact of the Non-financial Default, determined by the Non-defaulting Party as follows:

<b>Impact of Default</b>	<b>Description</b>	<b>Cure Period</b>
Safety - Immediate	A Non-financial Default that could result in immediate injury or loss of life (e.g., exposed wires, destroyed station fence, etc.).	Promptly
Safety - Potential	A Non-financial Default that could result in injury or loss of life if a single contingency were to occur (e.g., substandard grounding)	Promptly
Environment – Immediate	A Non-financial Default that could result in immediate adverse effects on land, air, water, plants, or animals	Promptly
Asset Integrity	A Non-financial Default that could adversely affect the ability of an asset to operate within prescribed ratings (voltage, thermal, short circuit) or be maintained to required standards for the purpose of prolonging the lifespan of the asset or satisfying safety or environmental requirements	Promptly
Environmental - Potential	A Non-financial Default that could, if a single contingency were to occur, result in adverse effects on land, air, water, plants, or animals	30 days
Power Quality	A Non-financial Default that could result in a variation in electric power service that could cause the failure or improper or defective operation of end-use equipment, such as voltage sag, overvoltage, transients, harmonic distortion and electrical noise	30 days

C.3. Where a Non-financial Default can have more than one impact and the impacts have different

Cure Periods, the shortest of the Cure Periods shall apply.

**SCHEDULE D  
FAULT LEVELS AND MODIFICATIONS REQUIRING APPROVAL BY THE  
TRANSMITTER**

**D.1. FAULT LEVELS**

[to be completed by the Parties and updated as required, using Attachment D1 or an amended version of Attachment D1 if desired]

**D.2. MODIFICATIONS REQUIRING APPROVAL BY THE TRANSMITTER**

D.2.1. In accordance with sections 28.2.5 and 28.2.6, the following modifications to the Customer's facilities may not be made by the Customer without the prior approval of the Transmitter:

[to be completed by the Parties]

**Attachment D1**

**Fault Levels  
(as permitted by section D.1 of Schedule D)**

Tariff Delivery Point	Supply Voltage (kV)	Tx Connection Point Number	Tx Connection Point	Fault Level (kA)

## **SCHEDULE E**

### **GENERAL TECHNICAL REQUIREMENTS**

#### **1.1 Guidelines of Reliability Organizations**

- 1.1.1. Customers and Transmitters shall follow all reliability organizations' standards as they may be amended from time to time.
- 1.1.2. The Transmitter shall provide to Customers upon request, the address and contact persons at the relevant reliability organization.

#### **1.2 Isolation from the Transmission System**

- 1.2.1. The Customer shall provide an isolating disconnect switch or device at the point or junction between the Transmitter and the Customer, i.e., at the point of the interconnection, which physically and visually opens the main current-carrying path and isolates the Customer's facility from the transmission system.
- 1.2.2. The isolating disconnect switch shall meet the following criteria:
  - 1.2.2.1. it shall simultaneously open all phases (i.e., group-operated open/close) to the connection;
  - 1.2.2.2. it shall be lockable in the open and closed positions;
  - 1.2.2.3. when the device is used as part of the HVI failure protection system, it shall be motor-operated and equipped with appropriate control circuitry; and
  - 1.2.2.4. it shall be suitable for safe operation under the conditions of use.

#### **1.3 Protection and Control**

- 1.3.1. The protection systems, which protects transmission system elements, shall be capable of minimizing the severity and extent of disturbances to the transmission system while themselves experiencing a first-order single contingency such as the failure of a relay protection system to operate or the failure of a breaker to trip. In particular:
  - 1.3.1.1. the elements designated by the Transmitter as essential to system reliability and security shall be protected by two protection systems. Each system shall be independently capable of detecting and isolating all faults on those elements. These elements shall have breaker failure protection, but breaker failure

protection need not be duplicated. Both protection systems shall initiate breaker failure protection;

- 1.3.1.2. to reduce the risk of both systems being disabled simultaneously by a single contingency, the protection system designs shall not use components common to the two systems;
- 1.3.1.3. the use of two identical protection systems is not generally, recommended, because it increases the risk of simultaneous failure of both systems due to design deficiencies or equipment problems;
- 1.3.1.4. the protection systems shall be designed to isolate only the faulted element. For faults outside the protected zone, each protection system shall be designed either not to operate or to operate selectively in coordination with other protection systems;
- 1.3.1.5. Customer protection settings for protections affected by conditions on the transmission system shall be coordinated with those of the transmission system;
- 1.3.1.6. protection systems shall not operate to trip for stable power swings following contingencies that are judged by protection system designers as not harmful to the transmission system or its Customers;
- 1.3.1.7. the components and software used in all protection systems shall be of proven quality for effective utility application and following good utility practice;
- 1.3.1.8. critical features associated with the operability of protection systems and the high voltage interrupting device (HVI) shall be annunciated or monitored;
- 1.3.1.9. the design of protection systems shall facilitate periodic testing and maintenance. Test facilities and procedures shall not compromise the independence of the redundant protection systems. Test switches shall be used to eliminate the need to disconnect wires during testing;
- 1.3.1.10. the two protection systems shall be supplied from separate secondary windings on one voltage transformer or potential device and from separate current transformer secondary windings, i.e., from two separate current transformers;
- 1.3.1.11. separately fused and monitored DC sources shall be used with the two protection systems. For all generating Facilities connected to the transmission system, two separate DC station battery banks shall be required to provide the required degree of reliability; and

- 1.3.1.12. protection system circuitry and physical arrangements shall be designed to minimize the possibility of incorrect operations from personnel error.
- 1.3.2. Specific protection and control practices and equipment requirements are set out in Schedule G of this Agreement.
- 1.3.3. Transmitters and Customers should apply protection systems, using the typical tripping matrix for transmission system protection shown in Exhibit E.2, of this Schedule E.

#### **1.4. Insulation Coordination**

- 1.4.1. Equipment connected to the transmission system shall be protected against lightning and switching surges. This shall include station shielding against direct lightning strokes, surge protection on all wound devices, and cable/overhead interfaces.
- 1.4.2. A tap connected to a shielded transmission circuit shall also be shielded.
- 1.4.3. The Transmitter shall review surge arrester ratings.
  - 1.4.3.1. The Transmitter shall provide all relevant Information, e.g., ratings, to Customers upon request. The Transmitter, however is not responsible for the adequacy of design or correctness of the operation of any equipment or apparatus including the surge arrester(s).

#### **1.5. Grounding**

- 1.5.1. Grounding installations shall be capable of carrying the maximum foreseeable fault current, for the duration of such fault currents, without risking safety to personnel that may be present on site when a fault occurs, damage to equipment, or interference with the operation of the transmission system.
- 1.5.2. Each transformer, switching, or generating station shall have a ground grid on which all metallic structures, metallic equipment and non-energized metallic equipment are solidly connected. The size, type and requirements for the ground grid are site-specific, depending on such factors as soil conditions, station size, and short-circuit level.
- 1.5.3. The Transmitter shall review the ground potential rise (GPR) study submitted by the Customer at the Customer's cost. The Customer shall comply with the Bell System Practices as they may be amended or modified from time to time and the IEEE standard 487 as it may be amended or modified from time to time for



providing special high-voltage protection devices on metallic communication cables. The Transmitter assumes no responsibility for the adequacy of design or correctness of the operation of any equipment or apparatus associated with the Customer's installation.

- 1.5.4. The placement of any additional grounding points on the transmission system shall require the approval of the Transmitter. The Transmitter shall give its approval if it is satisfied that the reliability of its transmission system is not affected.

## **1.6. Telemetry, Monitoring, and Telecommunications**

- 1.6.1. Transmitters shall advise Customers of the performance and details of required telemetering facilities that serve them. Some requirements depend on the size and specific location of the connection to the transmission system. As a minimum, telemetry shall be required for the flow of real and reactive power through circuits and transformers, the voltages at selected points, and the status (open or closed) of switching elements.
- 1.6.2. A Transmitter may require a Customer to install monitoring equipment to track the performance of its facilities, identify possible protection system problems, and provide measurements of power quality. The responsibility for costs will be as determined by the Board. As required, the monitoring equipment shall perform one or several of the following functions:
  - 1.6.2.1. sequence of events recording (SER) to record protection related events at a connection;
  - 1.6.2.2. digital fault recording (DFR) to permit analysis of transmission system performance under normal and abnormal conditions; or
  - 1.6.2.3. power quality monitoring (PQM) to record voltage transient surges, voltage sags and swells, voltage unbalance, supply interruptions, frequency variations and other voltage and current waveform monitoring.
- 1.6.3. Customers' telecommunications facilities shall be compatible with those of the Transmitter and have similar reliability and performance characteristics. At the Transmitter's discretion, some or all of the following functions may require telecommunication: protective relaying; system control and data acquisition (SCADA); voice communication; and special protection systems (e.g., generation rejection or runback).

- 1.6.4. Telecommunication facilities, design details, and performance requirements, associated with Customers' facilities, shall be provided at the Customer's expense.
- 1.6.5. The Customer shall bear all costs, without limitation, of providing the same telemetry data required under the Market Rules, associated with its facilities to the Transmitter and providing all required connection inputs to the Transmitter's disturbance-monitoring equipment, except:
  - 1.6.5.1. where the connection inputs to the Transmitter's disturbance-monitoring equipment are of mutual benefit to the Customer and the Transmitter, in which circumstance the Customer and Transmitter shall share the cost of providing the data in proportion to the benefits received; or
  - 1.6.5.2. where the connection inputs to the Transmitter's disturbance-monitoring equipment are required only for the Transmitter's benefit, in which case the transmitter shall pay all of the costs associated with providing the data.

## **1.7. Inspecting and Commissioning Procedures**

- 1.7.1. Customers shall ensure that any new or replacement equipment that they own is inspected and tested before initial connection to the transmission system. The initial verification tests shall confirm that the connection of the Customer's facility to the transmission system:
  - 1.7.1.1. does not pose any safety hazards;
  - 1.7.1.2. does not adversely affect operation of the transmission system in a material manner; and
  - 1.7.1.3. does not violate any requirement of the Code or this Agreement.
- 1.7.2. The Transmitter has the right to inspect the Customer's facility and witness commissioning tests related to any new or replacement equipment that could reasonably be expected to adversely affect the transmission system. The initial verification shall include high-voltage interrupting devices, line disconnect switches, the line and bus connections from the dead-end structure to Customer's facility, power transformers, surge arresters, DC batteries, and station service systems, protection, metering, and communication systems. The Customer shall have the right to the inspection reports relating to such facility.
- 1.7.3. The Transmitter assumes no responsibility for the adequacy of design or correctness of the operation of any equipment or apparatus associated with the Customer's installation. The Transmitter shall notify the Customer of its findings

regarding any potential problems or limitation of such equipment or apparatus owned by the Customer, without any responsibility.

- 1.7.4. The Customer shall advise the Transmitter of the commissioning program in writing, thirty business days before it proposes to begin the commissioning tests. The written notice shall include the connection commissioning schedule, the proposed test procedure, the test equipment to be used, and the transmission system conditions required, and also the name of the individual responsible for coordinating the proposed tests on the Customer's behalf.
- 1.7.5. Within fifteen business days of receiving the notice, the Transmitter shall notify the Customer that it:
  - 1.7.5.1. agrees with the proposed connection commissioning program and test procedures; or
  - 1.7.5.2. requires changes in the interest of safety or maintaining the reliability of the transmission system, and that such changes shall be sent to the Customer promptly.
- 1.7.6. If the Transmitter requires changes, then the Parties shall act in good faith to reach agreement and finalize the commissioning program within a reasonable period.
- 1.7.7. The Customer shall submit the results of the commissioning tests to the Transmitter and must demonstrate that all its equipment complies with the Code and this Agreement.
- 1.7.8. If the commissioning test reveals non-compliance with one or more requirements of the Code or this Agreement, the Customer whose equipment was tested shall promptly meet with the Transmitter and agree on a process aimed at achieving compliance.
- 1.7.9. The Transmitter may withhold permission to complete the commissioning and subsequent connection of the Customer to the transmission system if the relevant equipment fails to meet any technical requirement stipulated in the Code or this Agreement.
- 1.7.10. All reasonable costs incurred or associated with Transmitter's witnessing of the verification tests shall be borne by the Customer.







## **1.8. Procedures for Maintenance and Periodic Verification**

- 1.8.1. The Transmitter, using good utility practice, may specify the maintenance criteria and the maximum time intervals between verification cycles for those parts of Customers' facilities that may materially adversely affect the transmission system. The obligations for maintenance and performance re-verification shall be stipulated in the appropriate schedule to this Agreement.
- 1.8.2. Test switches shall be provided to isolate current and potential transformer input to the relays as well as a set of switches to isolate the relays tripping outputs from the power equipment control circuitry.
- 1.8.3. The reasonable cost of conducting maintenance and verification tests shall be borne by the Customer.
- 1.8.4. The Transmitter may appoint a representative to witness relevant maintenance and verification tests and the Customer shall permit the representative to be present while those tests are being conducted.
- 1.8.5. To ensure that the Transmitter's representative can witness the relevant tests, the Customer shall submit the proposed test procedures and a test schedule to the Transmitter not less than ten business days before it proposes to carry out the test. Following receipt of the request, the Transmitter may delay for technical reasons the testing for as long as ten business days. The Transmitter will use best efforts to make the required test date.
- 1.8.6. The reasonable costs associated with the witnessing of verification tests by the Transmitter's representative shall be borne by the Customer.
- 1.8.7. If a verification test reveals that the electrical equipment or protective relay system covered under the operations schedule does not comply with requirements, the Customer shall:
  - 1.8.7.1. promptly notify the Transmitter of that fact;
  - 1.8.7.2. promptly advise the Transmitter of its proposed remedial steps and its timetable for their implementation;
  - 1.8.7.3. diligently undertake appropriate remedial work and provide the Transmitter with monthly reports on progress; and
  - 1.8.7.4. conduct further tests or monitoring on completing the remedial work, to confirm compliance with the relevant technical requirements.

- 1.8.8. The Transmitter's reasonable costs associated with witnessing the performance tests following remedial work shall be borne by the Customer.
- 1.8.9. Customers shall make their maintenance records and verification test results, including up-to-date as-built drawings, available to the Transmitter upon request.

## SCHEDULE E (CONT'D)

### Exhibit E.1 Protection System Symbols and Devices

<u>Protection Systems - Symbols and Device Functions</u>	
51B	Transformer Phase Backup
50 / 51	Instantaneous / Timed Overcurrent
51V	Voltage Controlled Overcurrent
64	Line Ground Protection
79-25	Synchronizing Relay
A21 / B21	Line Phase Protection - A&B Group
A27 / B27	Undervoltage - A&B Group
A59 / B59	Overvoltage - A&B Group
A64-27 / B64-27	Ground Undervoltage - A&B Group
A64-59 / B64-59	Ground Overvoltage - A&B Group
A81U / B81U	Underfrequency - A&B Group
A81O / B81O	Overfrequency - A&B Group
A87 / B87	Transformer Differential - A&B Group
F	Failure Protection
L1, L2	Supply Line
T1, T2	Power Transformer
RT/TT	Remote or Transfer Trip for HVI Device Failure Protection
	Circuit Breaker
	Circuit Breaker with Reclosure
	HV Interrupting Device
	a) Circuit Breaker
	b) Circuit Switcher
	c) Vacuum Interrupter
	Motor Operated Disconnect Switch
	HV Transformer Bushing
	LV Transformer Bushing

## SCHEDULE E (CONT'D)

### Exhibit E.2 Typical Transmission System Protection Tripping Matrix

The following is a simplified tripping matrix showing the breakers that trip for different protection systems on the transmission system based on a single line supply to a Customer station or a transmitter's tapped transformer station operating, at the high voltage side, above 50 kV 50kV. The type of Customer (i.e., load or Generator) station configuration and other site-specific factors will influence the desired tripping matrix. The same approach can be applied to large 44-kV developments. In some applications, it may be desirable to trip the MV breaker for Line ZI/T operations instead of the HV Breaker.

PROTECTION FUNCTION	INITIATING PROTECTION							
	LINE ZI	LINE ZT	TTR LOCAL	XFRM	BUS	B/F HV	FRAME LEAK *	B/F MV
TRIP HV BREAKERS	T	T		T	T	T	T	T
HV BREAKER FAILURE	I	I		I	I			
HV AUTO-RECLOSE	C	C		C	C	C	C	C
BREAKERS			T	T	T	T	T	T
MV BREAKER FAILURE			I	I	I		I	
MV AUTO-RECLOSE					C	C	C	C
TTT	S					S	S	
OPEN XVR DISC				I				
TRIP ADJACENT HV ZONES						I		
TRIP ADJACEENT MV ZONES								I

T – trip breakers

I – initiate

C – cancel

S – send signal

HV – high voltage

TTR/T – transfer trip receive/transmit

ZI/T – impedance instantaneous/timed

B/F – breaker failure

MV – medium voltage

\* - Frame leakage protection is normally associated with 500kV breakers

All transmission system elements, including breakers, in the zones of protection shall be fitted with redundant protection systems if devices operated at more than 50 kV, except as noted.

All breakers in the zone of protection that includes devices operated at more than 50 kV shall be fitted with the non-redundant breaker failure-protection systems. Transmission system reliability, as determined by the IESO, may require breaker failure protection on the transformer MV breaker.

The Customer must be able to isolate (self-contain) his internal problems without having a major impact on the transmission system. Under certain circumstances, HV breakers may not be

required for load Customer step-down transformers, provided that a motorized disconnect switch and redundant communication channels and paths are provided to isolate the transformer at the terminal stations if a fault occurs in the transformer zone of protection.

Medium-voltage buses require either duplicated differential protection or a single differential protection with an overcurrent backup.



## **SCHEDULE F**

### **ADDITIONAL TECHNICAL REQUIREMENTS**

#### **1.1 Supply Considerations**

- 1.1.1 A high-voltage interrupting device (HVI) shall provide a point of isolation for the Generator's station from the transmission system. HVIs shall be provided with appropriate back-up protection. The HVI shall be a circuit breaker unless the Transmitter authorizes another device.
- 1.1.2 The HV side of the Generator's transformer shall be protected by surge arresters.
- 1.1.3 All protection systems shall be redundant and be complete with separate trip auxiliary relays and separately fused DC supplies.
- 1.1.4 The standard transformer winding connection for large Generators is LV delta – HV wye. Any other winding connections shall require the approval of the Transmitter. The Transmitter shall give its approval if it is satisfied that the reliability of its transmission system is not affected.
- 1.1.5 The method of grounding the neutral of all power transformer primary windings shall require the approval of the Transmitter. The Transmitter shall give its approval if it is satisfied that the reliability of its transmission system is not affected.

#### **1.2 Typical Generator Protection**

- 1.2.1 The typical technical requirements for Generator protection should be followed, as set out in Exhibit E.1 of Schedule E and Exhibits F.1 and F.2 of this Schedule F.
- 1.2.2 The typical Generator protections used are shown in Exhibit F.3 of this Schedule F.

#### **1.3 Protection against Internal Faults**

- 1.3.1 The Generator shall provide a protection package to detect and isolate faults on its equipment as required by the Transmitter to respect the stability and reliability of the transmission system, equipment ratings, and safety requirements.
- 1.3.2 Transmission system reliability may require two transformer differential protections (A87, B87) and low-voltage breaker failure protection, as shown in Exhibit F.2 of this Schedule F.

1.3.3 When two transformer differential protections are not required, one transformer differential and one overcurrent protection shall suffice. The timing of this overcurrent protection shall not exceed 1.6 seconds. The Customer shall coordinate all its internal overcurrent protections.

#### **1.4 Protection against External Faults**

1.4.1 The technique used for ground detection varies according to and depends on the type of winding configuration chosen for the power transformer.

1.4.1.1 if the transformer is connected ungrounded wye or delta on the primary, then ground undervoltage (64-27) and ground overvoltage (64-59) protections as shown in Appendix 11 are required to detect ground faults.

1.4.1.2 where the Transmitter has accepted a solidly grounded wye connection on the primary (Yg/D or Yg/Yg), ground overcurrent (64) protection(s) in the transformer neutral may be used to detect ground faults, as shown in Exhibit G.2 of Schedule G.

1.4.2 Typical protections that may be installed are: Distance Instantaneous and Timed (21), Phase Directional Overcurrent (67), Voltage Restrained Overcurrent (51V), Overcurrent (50/51), and Undervoltage (27), as shown in Exhibits F.1 and F.2 of this Schedule F.

1.4.3 To provide reliable phase-fault detection, the timed distance protection shall overreach the apparent impedance of the transmission line.

1.4.4 A remote/transfer trip system may be required to trip one or more breakers at the Generator's station or to trip breakers at a remote station.

1.4.4.1 generator protections that initiate opening of the remote supply breakers on the transmission system shall at the same time initiate opening of the main transformer high-voltage disconnect switch or line disconnect switch.

1.4.4.2 a signal that opens remote breakers on the transmission system shall be automatically removed when the main transformer disconnect switch or line disconnect switch opens. The signal shall only "seal-in" if the disconnect switch fails to open.

1.4.4.3 for DC remote tripping or transfer tripping, Generators shall provide all necessary equipment associated with two monitored teleprotection channels of adequate conductance between the Customer's station and one of the Transmitter's terminal stations or tapped stations. Normally two circuits in the same cable would be acceptable, but to satisfy transmission system requirements, two separate cables following separate routes may be required. Generators shall use relays and associated equipment following

good utility practice guidelines and are compatible with the Transmitter's remote trip or transfer trip equipment.

- 1.4.5 The protective setting to detect islanding/abnormal condition for smaller Generators shall be different from that used for larger Generators.
  - 1.4.5.1 protections that may be required to detect islanding/abnormal conditions include, but are not limited to, Overvoltage (59), Undervoltage (27), Voltage balance (60), Overfrequency (81 O), and Underfrequency (81 U), as shown in Exhibits F.1 and F.2 of this Schedule F.
  - 1.4.5.2 the frequency-protection settings on larger generating units shall coordinate with the provincial load-shedding system and with requirements of reliability organizations.
- 1.4.6 Blocking relays (21 BL) with remote signal-sending auxiliaries at the generating station and receiving auxiliaries at the transmission (terminal) station(s) may be required to prevent the Transmitter's distance relays from operating due to faults on the Generator's low-voltage bus. Communication media between the stations, similar to a single remote/transfer trip channel, would then be required for the blocking system, to prevent incorrect relay operation for this condition.

## **1.5 Autoreclosure and Manual Energization**

- 1.5.1 The Generator shall provide suitable equipment to protect its plant and equipment for any conditions on the transmission system such as reclosing, faults, and voltage unbalance.
- 1.5.2 Following a protection operation on a transmission line, the transmission breakers, located mainly in network switching and/or transformation stations, shall autoreclose after a certain time delay. Where the Generator is directly connected to the transmission line, or for configurations where the Generator could be damaged by autoreclosure of the line, the Generator shall provide a reliable means of disconnecting its equipment before autoreclosure. The Generator is responsible for protecting its own equipment and the Transmitter is not liable for damage to the Generator's equipment except as stipulated in section 15 of this Agreement. The Generator may request a means of supervising the transmission autoreclosure prior to the disconnection of its equipment e.g. changes in protection logic at one or both stations to reduce the risk of such events. The criteria governing the use of reclosures are set out in the Ontario Hydro "Policies, Principles & Guidelines" document "C-3.4.1(R1), Automatic Reclosure and Manual Energization on Bulk System Electricity Circuits", which was in effect as of April 1, 1999.
- 1.5.3 A Generator's transmission system breaker shall not autoreclose without the Transmitter's approval.

1.5.4 Manual energization of a Transmitter's line by a Generator's facilities is permitted only under the Transmitter's direction.

## SCHEDULE F (CONT'D)

### EXHIBIT F.1 TYPICAL GENERATOR PROTECTION REQUIREMENTS

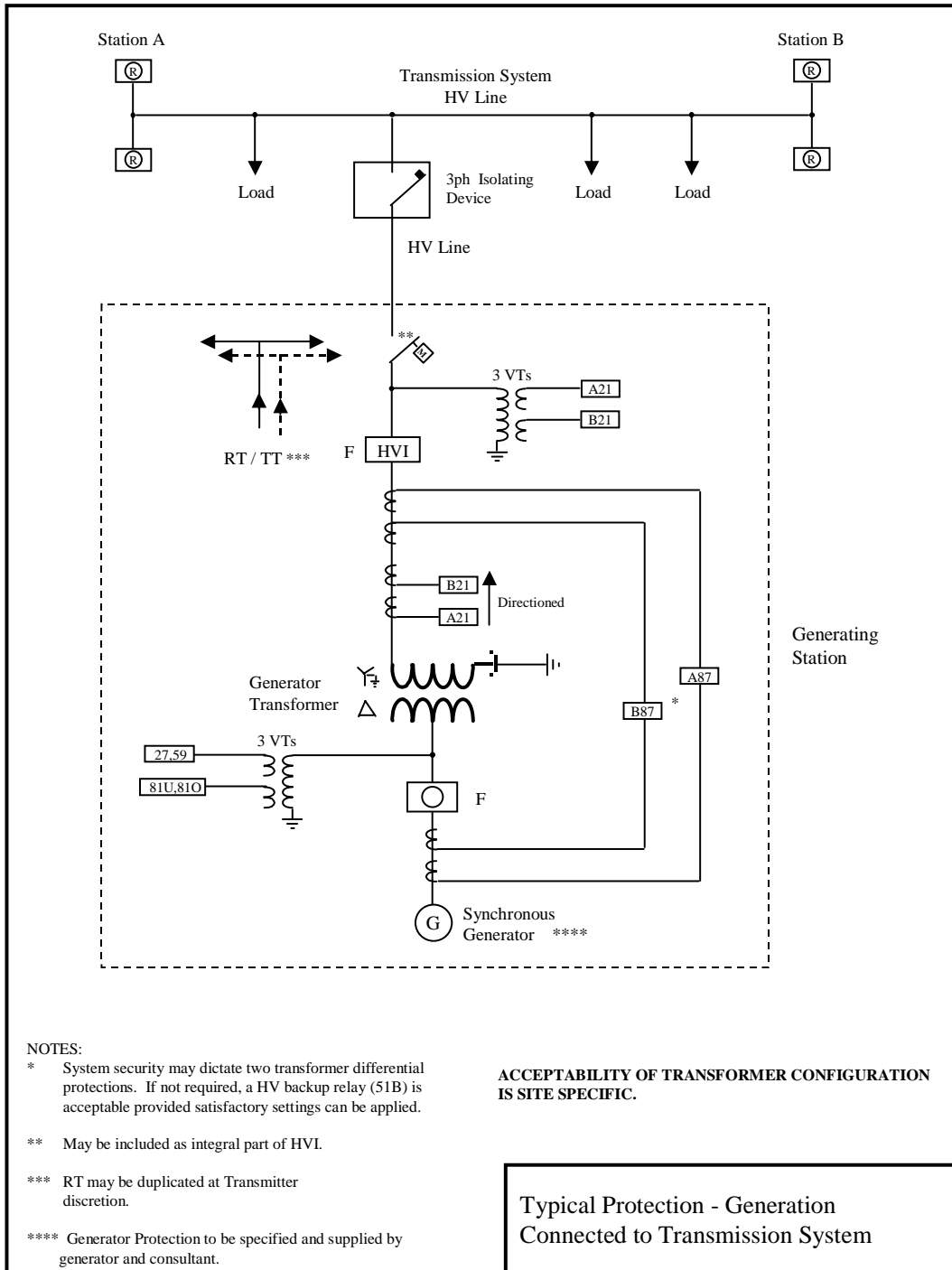



## SCHEDULE F (CONT'D)

### EXHIBIT F.3      TYPICAL GENERATOR PROTECTIONS

The following are typical Generator protections. The actual ones are to be specified and supplied by the Generator and his consultants. The Transmitter will be interested in the capabilities and settings of the frequency protections and voltage protections. The settings of the frequency protections on large units must comply with NPCC performance requirements. All protections settings must be submitted to the Transmitter and the IESO.

#### Typical Protections

<b>Thermal Units</b>	<b>Protections</b>	<b>Hydraulic Units</b>	<b>Protections</b>
<b>Differential</b>	<b>A87,B87</b>	<b>Differential</b>	<b>A87,B87SP</b>
<b>Stator Ground</b>	<b>A64N,B64N</b>	<b>Stator Ground</b>	<b>A64N,B64N</b>
<b>Loss of Excitation</b>	<b>A40,B40</b>	<b>Loss of Excitation</b>	<b>B40</b>
<b>Phase Unbalance</b>	<b>A46,B46</b>	<b>Phase Unbalance</b>	<b>A46</b>
<b>Over/under frequency</b>	<b>B81H,B81L</b>	<b>Overvoltage</b>	<b>A59</b>
<b>Over/under excitation</b>	<b>A59H,A59L</b>	<b>Phase Backup</b>	<b>B21B</b>
<b>Out-of-step</b>	<b>B21</b>	<b>Over/under frequency</b>	<b>B81H,B81L</b>
<b>Low Forward Power</b>	<b>A32,B32</b>	<b>Condense-to-Generate</b>	<b>B81-83</b>
<b>Sup Start Phase</b>	<b>A50S</b>		
<b>Sup Start Ground</b>	<b>A64S</b>		
<b>U/F Supervision</b>	<b>A81S</b>		
<b>Speed Switch</b>	<b>A14S</b>		

## **SCHEDULE G**

### **PROTECTION SYSTEM REQUIREMENTS**

- 1.1 Telecommunications
  - 1.1.1 The telecommunication facilities, used for protection purposes, shall have a level of reliability consistent with the required performance of the protection system.
  - 1.1.2. Transmitters shall specify telecommunication channel media and protective systems.
  - 1.1.3. Telecommunication circuits used for the protection and control of the transmission system shall be dedicated to that purpose.
  - 1.1.4. Where each of the dual protections protecting the same system element requires communication channels, the equipment and channel for each protection shall be separated physically and designed to minimize the risk that both protections might be disabled simultaneously by a single contingency.
  - 1.1.5. Telecommunication systems shall be:
    - 1.1.5.1. designed to prevent unwanted operations such as those caused by equipment or personnel;
    - 1.1.5.2. powered by the station's batteries or other sources independent from the power system; and
    - 1.1.5.3. monitored in order to assess equipment and channel readiness.
  - 1.1.6. Major disturbances caused by telecommunication failures shall have annual frequency of less than 0.002 per year from the dependability aspect and less than 0.002 per year from the security aspect.
  - 1.1.7. Telecommunication protection for a single transmission system circuit shall have an unavailability less than forty two (42) minutes per year, and for two circuits it shall be less than four (4) minutes per year.
  - 1.1.8. The telecommunication false-trip rate used as part of a protection system for a single transmission system circuit shall be not more than 0.1 false trips per year, and for two circuits it shall be not more than 0.001 false trips per year.
  - 1.1.9. Total transmission system circuit trips coincident with telecommunications failure shall be not more than 0.001 per year.

### **1.2. Test Schedule for Relaying Communication Channels**



- 1.2.1. Communication channels associated with protective relaying shall be tested at periodic intervals to verify that the channels are operational and that their characteristics lie within specific tolerances. The testing consists of signal adequacy tests and channel performance tests.
  - 1.2.1.1. Signal adequacy test intervals are:
    - 1.2.1.1.1. Channels - for Protection (unmonitored) at one (1)-month intervals; and
    - 1.2.1.1.2. Channels - for Protection (monitored) at twelve (12)-month intervals.
  - 1.2.1.2. Channel performance testing on leased communication circuits shall be conducted at 24-month intervals, while intervals for testing power line carrier equipment shall be equipment-specific.

### **1.3. Verification and Maintenance Practices**

- 1.3.1. Customers shall perform routine verifications of protection systems on a scheduled basis in accordance with applicable reliability standards. The maximum verification interval is four years for most 115-kV elements, most transformer stations, and certain 230-kV elements and two years for all other high- voltage elements. All newly commissioned protection systems shall be verified within six months of the initial in-service date of the system.
- 1.3.2. Routine verification shall ensure with reasonable certainty that the protections respond correctly to fault conditions.
- 1.3.3. An electrically initiated simulated-fault clearing check is mandatory to verify new protections, after any wiring or component changes are made to a protection, and for routine verification of a protection.
- 1.3.4. Customers shall ensure that the functional testing of protection and metering can be properly performed and that all verification readings are obtainable.
- 1.3.5. The Transmitter shall co-ordinate the initial verification upon receipt of the approved and final set of drawings. The initial verification shall be used during the final commissioning phase of the station and shall be used as a basis for future periodic verifications.

- 1.3.6. Transmitters and Customers shall agree upon the final functional test procedures before the tests begin. If they cannot agree, the supply or continuity of supply shall depend on the performance of the tests that the Transmitter shall require.
- 1.3.7. Before the initial functional tests are performed, the Customer shall supply the Transmitter with written documentation that shall readily provide confirmation that appropriate verifications have been completed and that all calibrations, tests, etc., have been performed. For components that may affect the transmission system (such as relays, meters, etc.), the Customer must satisfy the Transmitter that the proper settings have been applied.
- 1.3.8. Customers shall make available to the Transmitter records of relay calibrations and protection verifications, so that records of the facility's performance can be maintained. The specific records required shall be identified in this Agreement.

#### **1.4. Functional Tests and Periodic Verification**

- 1.4.1. Upon verification that the Customer's static tests on protection and control equipment, outlined in the Code and this Agreement, have been satisfactorily completed, a series of tests shall be performed with the equipment in a dynamic mode. These tests shall ensure that the equipment performs correctly when it should and also that it will not operate improperly.
- 1.4.2. These tests are here described only in general terms, since the specific tests to be performed will differ depending on the particular station configuration, the components or equipment used, and the design philosophy of the circuitry.
- 1.4.3. For DC circuitry checks, the logic of the auxiliary circuitry shall be thoroughly checked with the DC applied and the initiating devices suitably energized to initiate the process. When primary relays are the initiating device, the initiation shall be achieved by secondary injection of appropriate electrical quantities to the measuring elements. In certain cases where the sequence of operation is critical, monitoring by a portable sequence-of-events recorder may be required for proper analysis. Operation/tripping of all interrupting/isolating devices shall always be verified, as well as annunciation and target operation.
- 1.4.4. "On potential" checks shall follow all necessary preliminary procedures. The main equipment shall be energized but not placed on load. The Customer shall check all readings of potentials, including determination of correct phasing/phase rotation. The test must also demonstrate that all equipment performs as expected when energized and is in condition to have primary load applied.
- 1.4.5. Customers shall make "On-Load" checks following the application of appropriate load, voltage, current, phase angle or crossed wattmeter readings at the appropriate instrument transformer outputs or protection input points, to ensure that all quantities are appearing

as required with respect to magnitude, phase relation, etc. These checks are to determine that relays are properly connected and that the watt and var checks of all indicating and referenced equipment are correct. At times it may be necessary to repeat some or all tests, e.g., relay performance, using load currents.

### **1.5. Failure Protection for High-Voltage Interrupting Devices (HVIs)**

- 1.5.1. Provisions shall be made to clear the fault in case the HVI fails to isolate the fault. The requirements for HVI failure protection vary depending on the maximum permissible fault duration and the location of the connection on the transmission system. Some portions of the transmission system are designed and operated to more stringent requirements to avoid adversely affecting neighbouring transmission systems.
- 1.5.2. In general, the transmission system will require the HVI failure protection to be achieved by using remote or transfer trip circuits.
- 1.5.3. In portions of the transmission system having less stringent requirements, the HVI failure protection may be achieved by opening the motor-operated disconnect switch. If the disconnect switch experiences a flashover, the line protection at the transmission station(s) shall operate to isolate the fault.
- 1.5.4. Automatic ground switches are not acceptable for any new installations for triggering line protection operation following the failure of a HVI.
- 1.5.5. When circuit switchers are used, the interrupter and disconnect switch shall operate independently. Protections that trip the interrupter shall simultaneously initiate opening of the disconnect switch.
- 1.5.6. The DC voltage supplied to the interrupter and disconnect switch shall be fed from separately fused and monitored DC supplies: that is, by two (2) DC cables to the control cabinet.

### **1.6. Instrument Transformers**

- 1.6.1. Current transformer output shall remain within acceptable limits for all anticipated fault currents and for all anticipated burdens connected to the current transformer.
- 1.6.2. Current transformers shall be connected so that adjacent relay protection zones overlap.
- 1.6.3. Voltage transformers and potential devices shall have adequate volt-ampere capacity to supply the connected burden while maintaining their accuracy over the specified primary voltage range.
- 1.6.4. For each independent protection system, separate current and voltage transformer or potential device secondary windings shall be used, except on low-voltage devices.

1.6.5. Interconnected current transformer secondary wiring and voltage transformer secondaries shall each be grounded at only a single point.

### **1.7. Battery Banks and Direct Current Supply**

1.7.1. The Customer shall ensure that if either the battery charger fails or the AC supply source fails, the station battery bank shall have enough capacity to allow the station to operate for at least eight hours for a single battery system or at least six hours for each of the batteries in a two battery system.

1.7.2. Critical DC supplies shall be monitored and annunciated such as relay protection circuits and high voltage interrupters (HVIs).

1.7.3. For all generating facilities connected to the transmission system, two separately protected (fuse/breaker) and monitored DC station battery systems are required.

1.7.4. For tap transformer stations, one protected (fuse/breaker) monitored DC station battery system is required unless two systems are specified by the Transmitter.

1.7.5. Where two battery systems are required, there shall be a battery transfer scheme.

1.7.6. Where the use of a single battery system is allowed, the following conditions shall be met:

1.7.6.1. it can be tested and maintained without removing it from service;

1.7.6.2. each protection system shall be supplied from physically separated and separately fused direct current circuits; and

1.7.6.3. no single contingency other than failure of the battery bank itself shall prevent successful tripping for a fault.

**SCHEDULE H**  
**FACILITIES DEEMED COMPLIANT AND OBLIGATION TO COMPLY**

**H.1. IDENTITY OF DEEMED COMPLIANT FACILITIES**

H.1.1. The following Customer facilities are deemed compliant in accordance with section 4.6.1 of the Code:

[to be completed by the Parties, including identity of the facilities and the extent of non-compliance]

H.1.2. The following Transmitter's transmission facilities are deemed compliant in accordance with section 4.6.1 of the Code:

[to be completed by the Parties, including identity of the facilities and the extent of non-compliance]

**H.2. COMING INTO COMPLIANCE**

H.2.1. The Transmitter may, where the Board has approved its rules and procedures referred to in section 4.6.3 of the Code, require that some or all of the Customer's facilities to which section 4.6.1 of the Code applies be brought into actual compliance with the basic general performance standards and technical requirements set out in the Code, including in Appendix 2. The Transmitter may impose this requirement in relation to such facilities whether or not they are identified in section H.1.1. The Transmitter may impose this requirement only:

- (a) in relation to that portion of the Customer's facilities in respect of which the Transmitter has made a determination referred to in section 4.6.2 of the Code; and
- (b) in accordance with the Transmitter's Board-approved rules and procedures referred to in section 4.6.3 of the Code.

H.2.2. The Customer shall, upon being required by the Transmitter to do so under section H.2.1, bring its facilities into actual compliance with the basic general performance standards and technical requirements set out in the Code, including in Appendix 2, to the extent required by the Transmitter and in accordance with the rules and procedures referred to in section H.2.1(b). Responsibility for the costs of bringing such facilities into actual compliance shall be determined in accordance with the Transmitter's Board-approved rules and procedures referred to in section 4.6.3 of the Code.

H.2.3. Where Customer facilities are brought into actual compliance under section H.2.2, the Parties shall amend section H.1.1 as required.

H.2.4. Where the Transmitter's transmission facilities are brought into actual compliance, the Parties shall amend section H.1.2 as required.



## SCHEDULE I

### EXCHANGE OF INFORMATION

#### **I.1. INFORMATION TO BE PROVIDED BY THE TRANSMITTER**

- I.1.1. Subject to section I.1.2, the Transmitter shall, at the Customer's request, provide the following information to the Customer provided that such information is available at the relevant time:
- (a) feeder amperes per phase;
  - (b) bus voltage;
  - (c) real and reactive power flow per feeder (where available; otherwise per bus level);
  - (d) feeder breaker open/close status;
  - (e) feeder breaker recloser blocked/not blocked status;
  - (f) bus tie breaker open/close status;
  - (g) capacitor bank breaker open/close status; and
  - (h) transformer/bus breaker open/close status.
- I.1.2. The Customer shall be entitled to the information referred to in section I.1.1 only to the extent that:
- (a) the information relates specifically to the connection of its own facilities;
  - (b) the information is relevant to the connection of its own facilities; and
  - (c) the Transmitter is not prohibited by its confidentiality obligations as set out in the Code or its licence from providing that information to the Customer.
- I.1.3. The Transmitter shall provide the Customer with the following additional information:
- (a) at the Customer's request, a "relay and breaker trip report" for any operation of a breaker or transfer trip relay and that includes the date and time of the breaker or transfer trip operation and reclose or close, the cause of the incident if known and the quantity of load lost;
  - (b) megawatt and megavar readings, excluding revenue-metered quantities; and

- (c) [any additional information items as determined by the Parties to be required based on site specific considerations]

I.1.4. A Transmitter may provide information under section I.1.1 or I.1.3 by means of posting the information on a website that is dedicated to the Customer.

## **I.2. INFORMATION TO BE PROVIDED BY THE CUSTOMER**

I.2.1. To the extent that it has not already been provided to the Transmitter, the Customer shall provide the Transmitter with the same technical information provided to the IESO during any connection assessment and facility registration processes associated with the Customer's facilities or any new, modified or replacement Customer Facilities. Such information shall be provided in the form outlined in the applicable sections on the IESO's public website.

I.2.2. The Customer shall provide the Transmitter with updated versions of the technical information referred to in section I.2.1 in the event of a material change in such information.

I.2.3. The Customer shall provide the Transmitter with such information as the Transmitter may reasonably require in order to perform a Customer Impact Assessment.

I.2.4. To the extent that it has not already been provided to the Transmitter under another section of this Agreement or is not reasonably expected to already be known by the Transmitter, the Customer shall provide the Transmitter with the date and time at which the Customer's facilities are connected or reconnected to, or disconnected from, the Transmitter's transmission facilities.

I.2.5. The Customer shall notify the Transmitter in the event that its facilities are not being operated or maintained in accordance with the requirements of this Agreement.

I.2.6. The Customer shall provide the Transmitter with the following additional information:

- (a) the date and time at which any of the Customer's supply circuit breakers or high voltage interrupting switches automatically trips;
- (b) information pertaining to the operation of any of the Customer's automatic protective relays that has an impact on the Transmitter's transmission facilities;
- (c) changes in the Customer's operating setup or operating diagrams relative to the information contained in Schedule A or any updates or amendments thereto;
- (d) at the Transmitter's request, line and load data required for protective relay settings;



- (e) at the Transmitter's request, protective relay settings on equipment protection systems; and
- (f) at the Transmitter's request, annual facility performance data as may be required to enable the Transmitter to meet its reporting obligations to any reliability organization.

### **I.3. INFORMATION TO BE PROVIDED BY EITHER PARTY**

I.3.1. Each Party shall provide the other with the following information:

- (a) any temporary or permanent changes in the configuration of the Party's facilities that may affect the security of those facilities, load distribution, protective relay settings or other parameters;
- (b) details of defective equipment or hazardous conditions that may become known to the Party's Controlling Authority but not to the Controlling Authority of the other Party;
- (c) planned changes in the Party's facilities that affect the operation of those facilities; and
- (d) such other information as the other Party may reasonably require for the purpose of fulfilling its obligations under this Agreement.

I.3.2. Where applicable, the Parties shall amend Schedule A to reflect any information provided by a Party to the other under this Schedule.

**SCHEDULE J**  
**CONTACTS FOR PURPOSES OF NOTICE**

[To be completed by the Parties]

**SCHEDULE K  
SPECIAL PROVISIONS**

**K.1. LIABILITY**

- K.1.1. Despite section 15.1.2 but subject to sections K.1.2 and K.1.3, where the Customer uses the Transmitter's breakers as HV interruption devices or for the purpose of synchronizing the Customer's facilities to the Transmitter's transmission system, the Transmitter shall not be liable to the Customer for any damage arising out of such use, even where such damage is arises out of the negligence or willful misconduct of the Transmitter.
- K.1.2. Subject to section K.1.4, where damage occurs to the Customer's main output transformer ("MOT") due to the negligence or wilful misconduct of the Transmitter, the Transmitter shall be liable to the Customer in an amount equal to:
- (a) the cost of repairing the MOT; or
  - (b) the cost replacing the MOT,
- whichever is the lower.
- K.1.3. Subject to section K.1.4, where damage occurs to the Customer's electrical equipment upstream of the Customer's MOT but within the powerhouse due to the negligence or wilful misconduct of the Transmitter, the Transmitter shall be liable to the Customer in an amount equal to 45% of the Customer's Party Losses associated with such damage.
- K.1.4. In no event shall the Transmitter be liable to the Customer under section K.1.2 or K.1.3 in an amount greater than \$25 million for any event of negligence or wilful misconduct by the Transmitter. The Parties agree that this limitation of liability applies whether the damage suffered by the Customer is covered under section K.1.2, section K.1.3 or both.
- K.1.5. This section K.1 shall cease to apply in relation to any Party Losses suffered by the Customer that arise out of the negligence or wilful misconduct of the Transmitter on or after the date on which the Customer ceases to use the Transmitter's breakers as HV interruption devices or for the purposes of synchronizing the Customer's facilities to the Transmitter's transmission system.

**K.2. CUSTOMER-OWNED BREAKERS**

- K.2.1. Within five years of the date of coming into force of this Agreement, the Parties shall conduct and complete studies concerning the installation by the Customer of its own breakers for HV interruption and for the purposes of synchronizing the Customer's facilities to the Transmitter's transmission system. The Parties shall then determine

whether the installation of additional breakers by the Customer is warranted, and shall advise the Board of such determination.

- K.2.2. Responsibility for any incremental costs incurred by the Transmitter as a result of the Customer not having its own breakers for HV interruption or for the purposes of synchronizing the Customer's facilities to the Transmitter's transmission system shall be determined by the Board.